

GUIDELINES FOR WORKSHOP PRACTICE

Forming PLEXIGLAS®

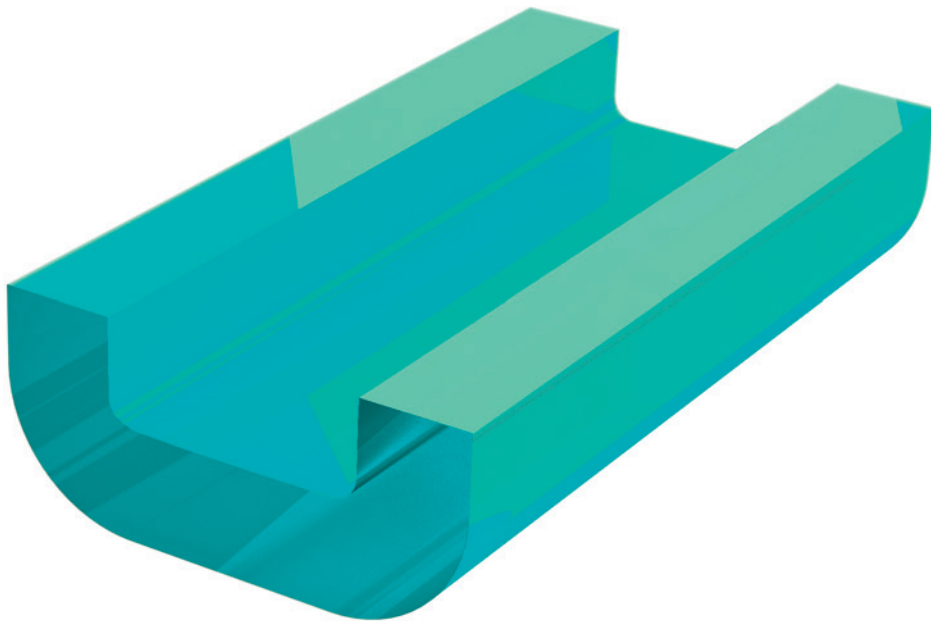

Contents

1. General remarks	3
1.1 Physical forms.....	3
1.2 Cutting-to-size and shrinkage.....	4
1.3 Masking film.....	4
1.4 Storage and pre-drying.....	4
2. Heating	5
2.1 Forming temperature.....	5
2.2 Heating period.....	5
3. Heating Methods	6
3.1 Heating by air.....	6
3.2 Area and linear heating by IR radiation.....	7
3.3 Contact heating.....	8
3.4 Other methods.....	8
4. Forming	9
4.1 Conditions and behavior.....	9
5. Forming Techniques	11
5.1 Forming by bending.....	11
5.2 Pressure forming.....	15
5.3 Slip-pressure forming.....	16
5.4 Stretch forming.....	16
5.5 Thermoforming on vacuum-forming machines.....	22
5.6 Thermoforming on presses.....	24
5.7 Thermoforming tubes and rods.....	26
6. Cooling	28
7. Tools	29
7.1 Molds.....	29
7.2 Clamps.....	31

Notes:

In addition to this publication, there are similar Guidelines for Workshop Practice for professional PLEXIGLAS® fabricators on:

Machining PLEXIGLAS®
(Kenn-Nr. 311-1)

Joining PLEXIGLAS®
(Kenn-Nr. 311-3)

Surface Treatment of PLEXIGLAS®
(Kenn-Nr. 311-4)

You can find valuable do-it-yourself hints on PLEXIGLAS® in

Fabricating Tips for PLEXIGLAS®
(Kenn-Nr. 311-5)

Special leaflets are available on the properties and fabricating behavior as well as the applications of several of our products, for example

- multi-skin and corrugated sheets,
- glazing with solid sheets,
- noise control barriers,
- signage and lighting

These can be obtained from your authorized distributor.

When using our products, please observe the following

- local building codes and emissions laws,
- applicable standards,
- product liability imposed by law,
- the guidelines of trade associations and liability insurers

1. General remarks

PLEXIGLAS® – the trademark for the acrylic glass (polymethyl methacrylate, PMMA) we were the first to introduce worldwide – is very versatile in use and also popular for its exceptionally good forming properties. PLEXIGLAS® GS is produced by casting, whereas PLEXIGLAS® XT is an extruded material.

Both types of PLEXIGLAS® undergo the temperature-related changes of state that are typical of amorphous materials: they become solid, thermoelastic, or show thermoplastic behavior. The reason lies in the different molecular weights of cast and extruded sheets, tubes, and rods.

This results in varying technical performance, which has to be taken into account primarily during forming.

Of particular interest for thermoforming is the thermoelastic range, in which a thermoplastic becomes „rubbery-elastic“ and can be formed, without cutting, by pressing, bending, or by stretching. The overview (Fig. 1) shows the state ranges through which PLEXIGLAS® GS and PLEXIGLAS® XT pass at different temperatures: cast (high-molecular-weight) PLEXIGLAS® GS shows predominantly thermoelastic behavior over a wide range of higher temperatures. Therefore, plastic deformation is practically non-existent in molded parts made from it, and the latter resume their original shape when reheated to the forming temperature (similar to an elastic spring). **As a result, shaping flaws can be corrected without loss of material.**

By contrast, the range in which extruded (low-molecular-weight) PLEXIGLAS® XT shows thermoelastic behavior is comparatively small. At higher temperatures, it becomes thermoplastic, i.e., acquires a dough-like consistency or forms a melt. Since there is no clear dividing line between the thermoplastic and thermoelastic states, however, a certain amount of plastic deformation – which depends on the forming temperature – remains in every for-

med item. Therefore, finished articles made of PLEXIGLAS® XT never quite return to their original shape on reheating. The deformation process is thus only partly reversible.

The typical differences between GS and XT also apply to PLEXIGLAS® products for specific applications, such as Soundstop (transparent noise protection) or with special surfaces. These can be scratchproof-coated, textured, or mirror-coated, or exhibit the Heatstop (solar-heat reflecting), Satinice (special delustrating), or NO DROP (water spreading) qualities.

Differences in the forming behavior or are pointed out in the respective section.

It is the aim of this brochure to help you achieve optimum work results. If you have any questions about our information or the practical work based on it, contact your authorized PLEXIGLAS® distributor or our **Technical Service** department. We would also appreciate any suggestions based on your experience in the field.

1.1 Physical forms

We produce PLEXIGLAS® GS in the form of solid flat sheets, blocks, tubes, and rods with smooth, matte, or burnished (PLEXIGLAS® Satinice) surfaces.

PLEXIGLAS® XT is available as traditional and impact-resistant-modified acrylic glass (PLEXIGLAS® Resist), as smooth, textured, matte, or burnished (PLEXIGLAS® Satinice) solid flat sheets, corrugated sheets, multi-skin sheets, mirrors, tubes, and rods as well as films.

Colored sheets are generally colored homogeneously throughout.

Whether standard or special sizes, all material packaged on pallets is labeled with information for correct storage and in-house transport. Generally speaking, PLEXIGLAS® is best stored indoors. All our sheets are wrapped in polyethylene sheeting, which can be readily disposed of. In the case of outdoor storage, carefully designed additional cover is necessary.

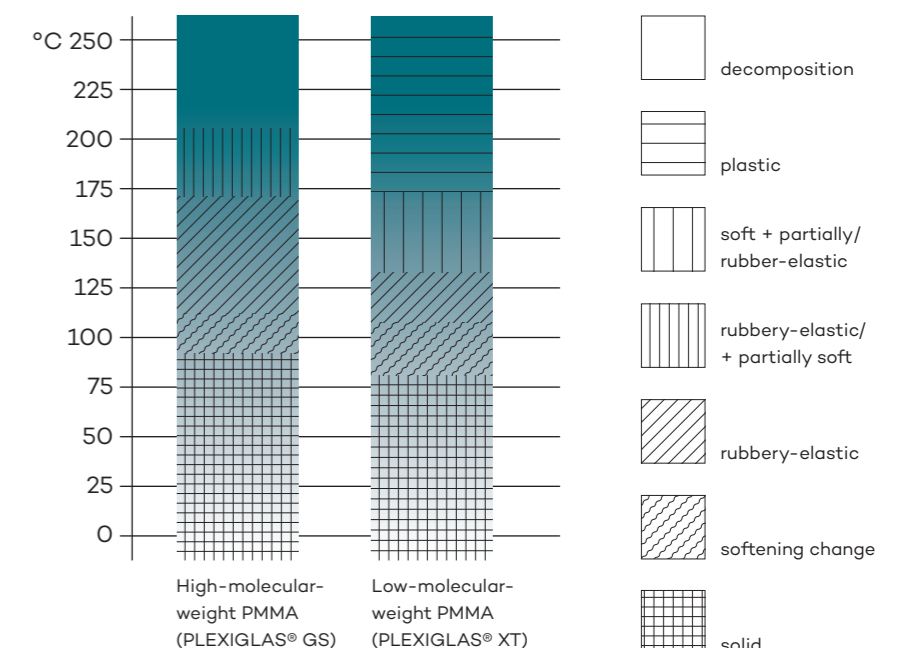

Fig. 1: Changes of state as a function of temperature

1.2 Cutting-to-size and shrinkage

When PLEXIGLAS® GS and PLEXIGLAS® XT are first heated beyond their softening temperature, they undergo a one-time shrinkage in length and width due to the manufacturing process. This change in dimensions may have to be allowed for when sheets intended for forming are pre-cut to size. With cast acrylic glass, the shrinkage is similar in length and width. With all extruded grades, it mainly occurs in the extrusion direction. It can be zero in the transverse direction, or the dimensions might even be slightly larger. For detailed information, see Fig. 2.

Shrinkage does not occur when the sheets are processed in vacuum-forming machines, but rather only when unclamped blanks are heated, such as in the oven. When in doubt, conduct a preliminary test.

1.3 Masking film

Depending on the grade and thickness, the surfaces of our sheets are masked with self-adhesive or cling film made of environment-friendly polyethylene (PE). Normally the surface masking should remain on the sheet until the finished article is ready for use. If it has to be removed before thermoforming or bonding, for example, hold the sheet firmly down at one edge and strip off the film with one **quick movement** of the hand.

If the sheets are exposed to the weather, all films must be **removed within four weeks**, regardless of their adhesive properties, since the polyethylene may become brittle after this period of time or adhere even more strongly. In either case the films can no longer be properly removed and the sheets might be damaged.

When the masking film is stripped off, the plastic surfaces become statically charged and attract dust. **Prior to forming, the sheet should therefore be given some antistatic treatment, such as rinsing with water containing a wetting agent or blowing with ionized air.** As a result of the manufacturing process, the surfaces on both sides of white and colored sheets of PLEXIGLAS® GS and XT differ slightly in quality. The quality is checked on the upper surface, i.e., the side suited to the application. It is therefore marked as such on the masking film.

1.4 Storage and pre-drying

Depending on the storage and climate conditions, most plastics absorb moisture. Although this can be disregarded for normal application temperatures, it may be the cause of bubble formation during heating when **extruded** acrylic glass is exposed to higher temperatures. We therefore recommend prolonged pre-drying in air-flow ovens at temperatures below the softening point of the material. Here, the sheets must have

been stripped of their masking films and the drying air must be able to circulate between them. For reasons of economy, forming should be performed immediately after pre-drying. It is important to remember that the sheets gradually reabsorb moisture when cooled to below 100°C. Given fast and effective heating, such as by infrared radiators, pre-drying can be dispensed with. Otherwise, the heating parameters must be established by trial and error, depending on the formed article. For line bending, pre-drying is normally not required.

Pre-drying of PLEXIGLAS® XT sheets prior to thermoforming can usually be dispensed with if the masking film is undamaged and the material has been correctly stored. Where this is not the case, pre-drying for 24 hours at 80°C is generally adequate, even for sheets with a comparatively high moisture content. Stacked sheets, especially of PLEXIGLAS® XT, should always be wrapped in PE sheeting in order to prevent rippling of the sheet edges as a result of moisture pickup. As opposed to tubes of PLEXIGLAS® GS, absorbed moisture may cause tubes of PLEXIGLAS® XT to develop optical distortions or form bubbles on heating or thermoforming. This can be avoided by pre-drying in an air-flow oven at ca. 70°C. The necessary drying time can be estimated as roughly one hour per millimeter of wall thickness.

2. Heating

Generally speaking, PLEXIGLAS® GS and PLEXIGLAS® XT should be heated as briefly as possible by air convection or infrared radiation at the lowest possible forming temperatures, in order to avoid changes in the material or molded item. In general, PLEXIGLAS® sheets with scratchproof coating **cannot be heated or thermoformed** (risk of the coating cracking). They may, however, be installed cold-curved.

Oven heating ensures a uniform temperature over the entire sheet surface, which is the first step to achieving good forming results. If **infrared radiators** are used to heat to the forming temperature—and also in the case of temperature-controlled mold frames—the blanks are best **preheated to ca. 80°C** in order to prevent subsequent warping of the molded item. Infrared radiation permits different temperatures on the sheet to be formed, to achieve a particular thickness distribution, for example.

In order to avoid excessively rapid cooling and thus solidification at the surface, the material is best heated directly at the mold.

The **heating period** increases with the material thickness, according to Fig. 3. Heat shrinkage, according to Fig. 2, must also be kept in mind.

2.1 Forming temperature

For forming in the thermoelastic/thermoplastic range, the recommended material temperatures are:

PLEXIGLAS® GS: 160 to 175 °C
PLEXIGLAS® XT: 150 to 160 °C

Depending on the degree and speed of forming (see 4.1), these temperatures may have to be varied up or down to preserve the good optical quality of the surface. In practice, it is therefore necessary to adjust the heating equipment in such a way that the above temperatures can be reached. The material temperature should be measured contact-free, such as by means of a radiation pyrometer.

As always, it is advantageous with PLEXIGLAS® GS and PLEXIGLAS® XT **to preheat the mold and clamping frame or contour plates used for forming:**

for PLEXIGLAS® GS and PLEXIGLAS® XT: ca. 60 to 80 °C

2.2 Heating period

The heating period for PLEXIGLAS® GS and PLEXIGLAS® XT depends above all on the material thickness and heating method used. Additional factors are the air velocity in the oven and the distance between the sheet and IR radiator. If IR radiators are used, the sheet color also plays a part, because the absorptance varies from color to color. The graph (Fig. 3) therefore schematically illustrates the heating required in an air-circulation oven and with infrared radiators as a function of the material thickness (example for PLEXIGLAS XT®). If heating occurs on one side only—which is only possible with material up to 6 mm thick—about twice the time is required.

Whereas PLEXIGLAS® GS is very tolerant of unnecessarily long heating periods, blanks of PLEXIGLAS® XT tend to warp when heated while vertically suspended (such as in a vertical oven or vacuum-forming machine) or show pronounced mark-off from the tray when heated horizontally, such as in a horizontal oven.

Sheet thickness				
Shrinkage on initial heating to forming temperature	PLEXIGLAS® GS	PLEXIGLAS® XT		
	In length and width all grades (except GS 215 STRECHED)	In the extrusion direction (negligible transversely) Surfaces Smooth Gallery AR Textured Satinice		
max. 2%	all thicknesses	–	–	–
max. 3%	–	≥ 3 mm	–	–
max. 6%	–	< 3 mm	all thicknesses	all thicknesses

Fig. 2: Heat shrinkage

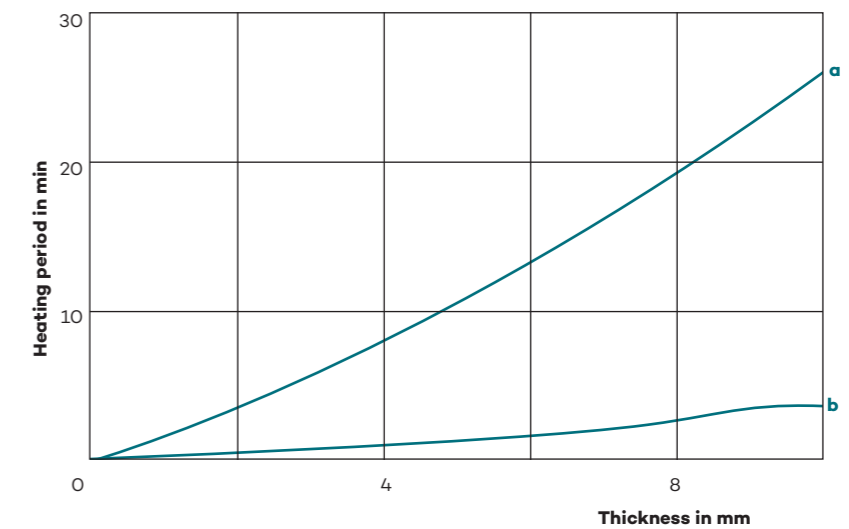

a = Oven T = 150 °C
b = IR-radiator with 10 kw/m², exposure on both sides at distance of 250 mm

Fig. 3: Heating period

3. Heating methods

Heating methods	
Heating by air	
Horizontal oven	<ul style="list-style-type: none"> for large blanks (especially of PLEXIGLAS® XT)
Vertical oven	<ul style="list-style-type: none"> uniform heating universal use (annealing, reverse forming) to a limited extent also for horizontal heating
Blower	<ul style="list-style-type: none"> for small special items
Panel heating	
Long-wave (dark radiator), ceramic, $\lambda = 3,5$ to $6 \mu\text{m}$	<ul style="list-style-type: none"> economical
Medium-wave, fused silica + translucent fused silica radiators $\lambda = 2,2$ to $2,7 \mu\text{m}$	<ul style="list-style-type: none"> optimum heating quick response
Short-wave (bright radiator), $\lambda = 0,9$ to $1,6 \mu\text{m}$	<ul style="list-style-type: none"> powerfull and quick "pulses" lower the risk of overheating
Linear heating (both sides recommended)	
Heating wires (with transformer)	<ul style="list-style-type: none"> up to ca. 6 mm sheet thickness
Heating rods	<ul style="list-style-type: none"> up to ca. 12 mm economical simple handling
Fused silica	<ul style="list-style-type: none"> powerfull up to block thickness most efficient type of heating
Contact heating	<ul style="list-style-type: none"> not advisable!

Fig. 4: Summary of the most common heating methods

3.1 Heating by air

Air-flow ovens are particularly suitable for heating PLEXIGLAS® GS and PLEXIGLAS® XT in the form of sheets, blocks, profiles, or tubes. A **vertical oven** will normally be the best choice, because large sheets are suspended in it contact-free for heating, while smaller cut-to-size blanks can be heated **horizontally**, similar to a drawer oven, on inserted grills.

A vertical oven is also essential for stress-free annealing, especially for larger molded parts, as well as for reverse forming of incorrectly formed parts, particularly those made from PLEXIGLAS® GS.

The following points should be observed:

- the temperature in the oven should be accurately adjustable to $\pm 3^\circ\text{C}$ when between 60° and 250°C .
- If the oven can be loaded from two sides, a temperature tolerance of $\pm 5^\circ\text{C}$ must not be exceeded.

- The air circulation must be as strong as possible (air velocity 60 to 90 m/min) in order to guarantee rapid and uniform heating.
- A reliable temperature control offers the advantage that heating programs can also be un after working hours.



Fig.5: Putting a suspended PLEXIGLAS® sheet into the oven

Sheets and tubes of PLEXIGLAS® GS and XT are best suspended in the oven to ensure uniform heating throughout. Doing this also avoids mark-off, except where clamped.

Large sheets of PLEXIGLAS® XT should be heated in a horizontal position to prevent them from warping, expanding, or slipping out of the clamps, due to their thermo-plastic behavior. Suitable supports are normally roughened or sandblasted aluminum sheets, PTFE-coated metal sheets, or special woven glass fabrics, because the heated material will not stick to them.

Small PLEXIGLAS® GS blocks can be placed in the oven on end. Larger blocks should be put on a cloth for sliding transfer to the mold.

If the same oven is used for other purposes, make sure that all materials that can cause corrosion or cracking are removed.

For partial heating, such as for bending tubes, hot-air blowers are the right equipment to use. Care must be taken that the affected areas are not overheated, however.

3.2 Area and linear heating by IR radiation

Infrared radiation for heating sheets of PLEXIGLAS® GS and PLEXIGLAS® XT has the advantage of transferring a higher heat output per unit of time than is possible in the oven. The heating period depends on the material thickness, color, type of sheet, as well as the type and distance of the IR radiators (IR radiators) and the wavelength of the radiation they emit. They are distinguished according to their maximum wavelengths:

Long-wave: $\lambda = 3,5 \mu\text{m}$ to $6,0 \mu\text{m}$ (Ceramic-, dark radiators)

Medium-wave: $\lambda = 2,2 \mu\text{m}$ to $2,7 \mu\text{m}$ (fused silica, translucent fused-silica radiators)

Short-wave: $\lambda = 0,9 \mu\text{m}$ to $1,6 \mu\text{m}$ (bright radiators, heating lamps)

Whereas the **long-wave dark radiators**, usually in the form of ceramic elements, emit a radiant energy which heats the sheet material mainly from the irradiated surface inward, the radiation with **short-wave radiators** has a higher energy density and penetrates more deeply, particularly into transparent material. In this case, however, part of the energy can pass through the sheet and thus not be absorbed.

Medium-wave radiators are ideal and are already state-of-the-art. The sheet is partly heated by the radiation incident to its surface and partly from within by the absorbed radiation. If the material is heated from one side only—as is common practice with thin sheets and films—transmitted radiation can be recovered by a reflector. Thick sheets should always be heated from both sides.

In order to work more economically and quickly, so-called "flash" radiators are also used for acrylic glass thermoforming. They work on short or

medium wavelengths and deliver the energy to the sheet in **pulses** (also to avoid overheating/combustion).

Where sheets of PLEXIGLAS® GS and PLEXIGLAS® XT are to be **heated over their entire area**, infrared heating panels are used. They are either firmly installed in a vacuum-forming machine or mounted in a mobile fashion to be used at different forming stations.

Even for simple forming jobs, it is advantageous to control infrared heating panel elements individually. In this case, the IR radiators in the perimeter areas can be set to a higher output than those in the center. This is the only way to ensure a uniform temperature over the entire sheet surface and compensate for the unfavorable cooling effect of the clamping frame.

Moreover, the ability to adjust individual sheet zones to different temperatures is an advantage when molding complex shapes.

By **covering up a defined area**, the center of the sheet, for example, can be excluded from heating. If necessary, the radiators above this area are switched off. This permits a thickness distribution in accordance with the desired molding shape. The original thickness, i.e., the rigidity

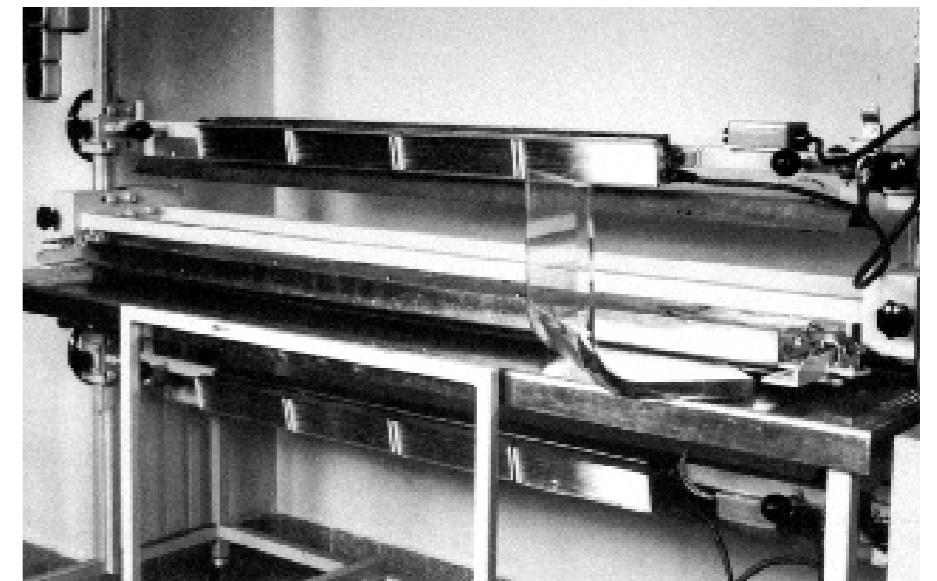

Fig. 6: Line bender with different IR radiators and line-bent PLEXIGLAS® component

of the sheet, its optical quality, and usually also its planarity, remain unchanged in the covered area. In the stretched edge zone, on the other hand, the thickness is noticeably reduced. If the sheet has been screen-printed, shielding this area prevents the print from being distorted.

If the sheet is not clamped in a forming frame as usual but rather heated flat, a sheet of woven glass fabric should be placed underneath during the heating process to avoid unwanted mark-off in the material.

Line benders, i.e., jigs equipped with heating wires, heating rods or quartz rods as heat sources, are suitable for **linear heating** of PLEXIGLAS® GS and PLEXIGLAS® XT.

When heating linearly prior to bending, **any contact with the heat source must be avoided** so as not to impair the good surface quality and transparency of PLEXIGLAS®. Moreover, heating on both sides is always preferable to heating on one side only.

The PLEXIGLAS® Satinice product group, with matte surfaces, also offers creative possibilities for line bending. The burnished finish remains along the heating line in the case of Satinice SC, DC, and Satinice, while Gallery AR becomes glossy.

Heating wires, which are usually made of special chrome vanadium alloy, are widely used. Since they are fed with low-voltage alternating current, a transformer is required for each of them. The wire in the heating jig must be kept tautly stretched by means of springs to prevent it from sagging when hot, thus altering its distance to the sheet and heating it irregularly. This technique can be used on sheets up to ca. 6 mm thick, especially when heating from both sides.

More favorable than heating wires are **heating rods** made of nickel chromium steel. The fact that they are held pointwise and are directly connected to the AC power line (220 V) makes them easier to handle than heating wires. If a longer heating rod is bent in a U-shape, for example, it is also possible to heat a sheet linearly from both sides. Two-sided heating with heating rods is recommended for sheets up to a thickness of ca. 20 mm.

Also used are **quartz tubes** with single or double spirals, which are also operated on 220 V. Their calorific output is normally higher than ne-

cessary for plastic sheets and must therefore be reduced. This is done by switching the tubes on and off via thermocouples or by using a thyristor circuit. Quartz tubes are the most effective heating elements, since they have the favorable characteristics of a medium-wave radiator. Because of the adjustable output and corresponding distance of the radiator to the workpiece, all sheet thicknesses up to blocks over 50 mm thick—especially when heating from two sides—can be heated linearly for line-bending or hot curving.

3.3 Contact heating

Heating with **heating plates** is generally limited to PLEXIGLAS® GS, in some cases PLEXIGLAS® XT, and then only when the blanks are small. The sheet thickness should not exceed 3 mm, since this type of heating is usually applied to one side only. Heating from both sides – such as on presses with heated plates – is not common, because the surface quality of PLEXIGLAS deteriorates in the process. Heating plates used with PLEXIGLAS® must not have smooth or polished surfaces. Sandblasted, dull aluminum plates and Tefloncoa-

ted plates have proven suitable for minimally marking the plastic sheets laid on them. Generally speaking, heating on plates is **not recommended**, since uniform heat distribution cannot be ensured.

Also not recommended is linear contact heating using a **heated blade**, since the marks produced in the area of the bend normally cannot be eliminated. Therefore, contact-free heating is preferable in all cases (see 3.2).

3.4 Other methods

Heating with an open flame, by **high-frequency vibrations**, or in **liquid baths** has **not been widely accepted** in practice. Heating by means of **hot-air blowers** can be **recommended under certain conditions**, for example to eliminate mark-off on moldings and to bend tubes. The stress they generate in the material is best relieved by annealing.

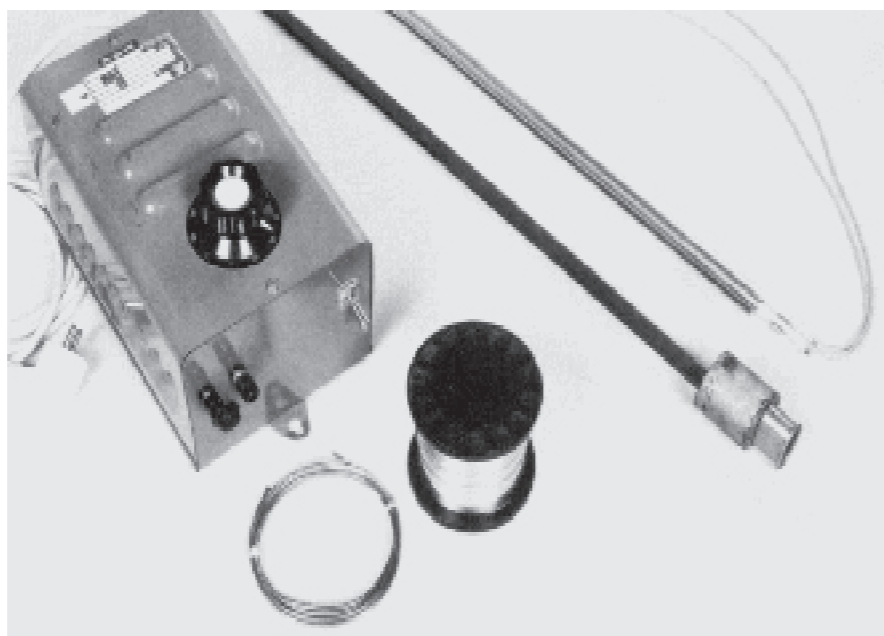

Fig. 7: Heating wires with transformer, heating rod, and quartz tube for linear heating

4. Forming

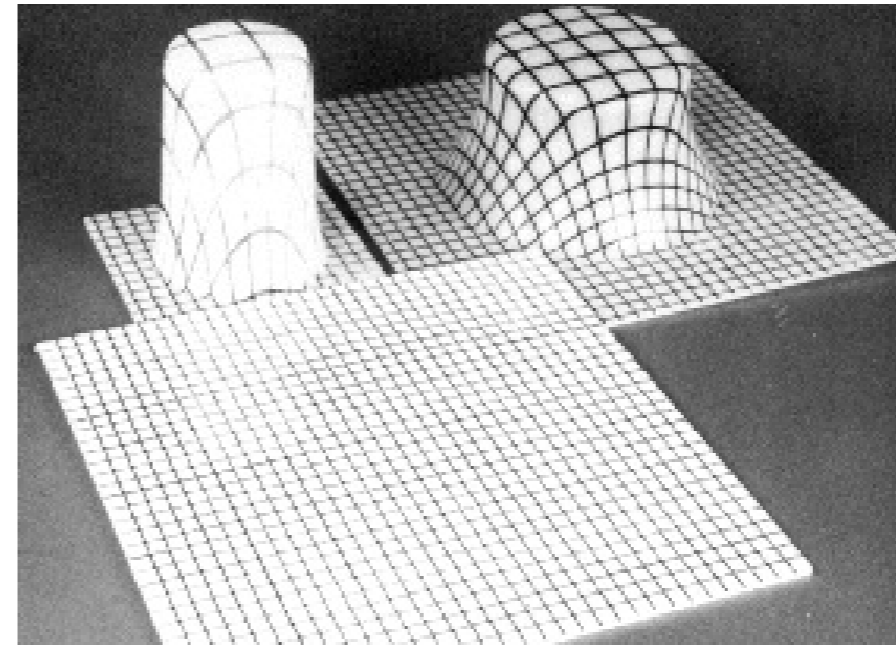

Fig. 8: Degree of stretching demonstrated by means of a grid

When forming PLEXIGLAS® GS and PLEXIGLAS® XT, the

- degree of stretching,
- forming forces,
- forming rates and
- forming temperatures (see 2.1)

depend chiefly on the practical requirements to be met by the molding and on its specific shape. The structure of the material varies accordingly and influences the behavior of the formed item.

In all these factors, the forming temperature has a major but widely varying influence, which may in fact be reversed. PLEXIGLAS® GS and XT can be highly stretched at relatively low temperatures. The forming process occurs more slowly and is of a rubbery nature, and the surface quality of the semifinished material is largely retained. Because the stress level is rather high, the molding shows a pronounced tendency to undergo elastic recovery. This tendency can be minimized only by forming at comparatively high temperatures. In practice this means that compromises always have to be made. The following sections will provide some help.

4.1 Conditions and behavior

The degree of stretching dictates the change in shape occurring during thermoforming of the semifinished product. With the most popular forming techniques, i.e., uni- and biaxial stretching, this change is characterized by an enlargement of the surface and a corresponding reduction in material thickness. The degree of stretching is defined as the ratio of either the mean material thickness or the surface area before and after forming. The following applies to biaxial stretching:

A 100% degree of stretching thus means that a square sheet is stretched to twice its size in length and width. During the process the surface enlarges from 100% before stretching to 400%, the original thickness reducing to one quarter.

In practice, the aim should normally be to obtain a more or less uniform degree of stretching and thus uniform thickness distribution within the finished item. This in turn depends on the shape of the item and the forming technique used (Fig. 8).

$$R = \left(\sqrt{\frac{d_0}{d_1}} - 1 \right) \cdot 100 [\%]$$

oder

$$R = \left(\sqrt{\frac{A_1}{A_0}} - 1 \right) \cdot 100 [\%]$$

R = degree of stretching in %
d0 = thickness prior to stretching
d1 = thickness after stretching
A0 = surface area prior to stretching
A1 = surface area after stretching

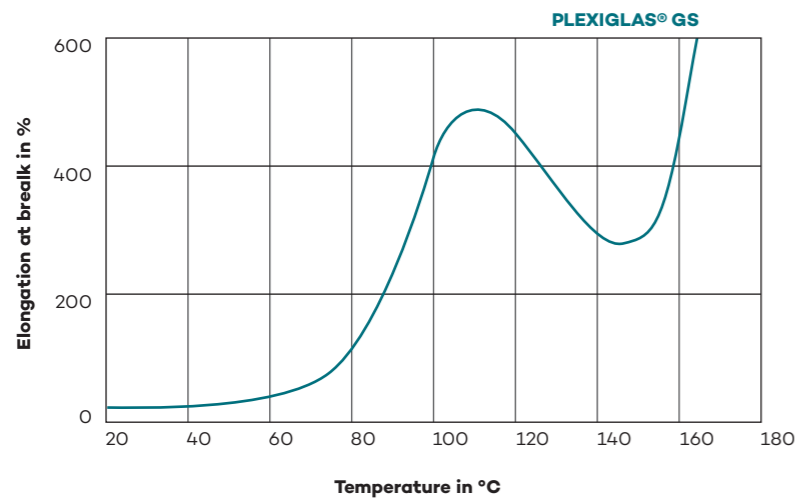

Fig. 9: Maximum degree of stretching (elongation at break) as a function of temperature for PLEXIGLAS® GS

However, Fig. 9 shows quite clearly that the maximum elongation at break is reached at temperatures which are too low for **optimum forming**, which, for technical reasons, is possible only at **higher temperatures**. Moreover, the heating temperature must be noticeably higher than the forming temperature, because the molding cools down after heating and before or during the forming process. In some cases it is best to continue heating the material throughout the forming process, independent of the degree of stretching.

In order to assure the stability of the forming equipment, it is necessary to

know the **forming forces** required for producing the moldings.

The force requirement in a particular case depends mainly on three factors:

1. the degree of stretching, which is determined by the shape of the workpiece or the ratio between the original surface area and that of the finished part,
2. the forming temperature, which may drop more or less sharply, depending on the duration of the forming process or if the mold temperature is too low,
3. whether stretching is uniaxial or biaxial.

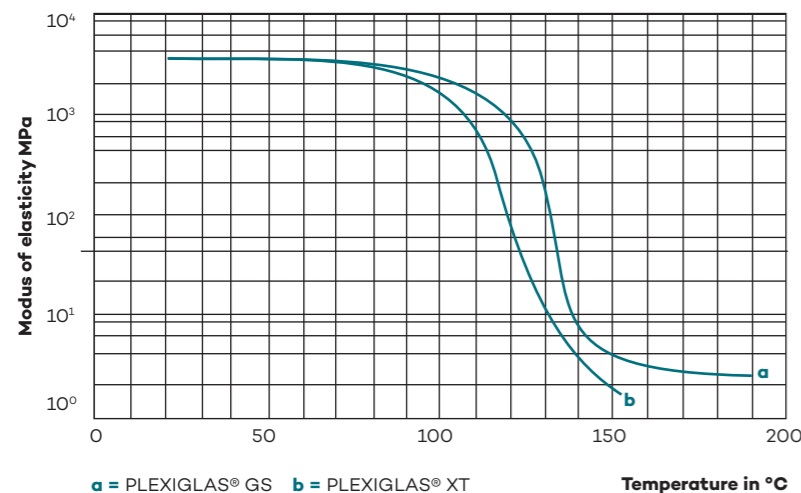

Fig. 10: The modulus of elasticity as a function of temperature

Fig. 10 shows the rigidity behavior at higher temperatures. Fig. 11, which is derived from Fig. 10, illustrates the influence of the degree of stretching on the forces required for uniaxial and biaxial stretching. For simple forming operations with a known profile for the degree of stretching, the force requirement for biaxial forming can be calculated from this graph. Given complex moldings whose degree of stretching (or its profile) cannot be predetermined, the forming forces must be established by trial and error or estimated on the basis of model tests.

The **forming rate** is the speed at which the material can be elongated or stretched in the thermoelastic range, without exceeding its strength and rupturing.

As a general rule, PLEXIGLAS® GS and XT should be formed **as quickly as possible** in order to

- achieve short cycle times,
- Prevent excessive cooling
- and save energy during the forming process.

On the other hand, the forming rate should be **low enough** to

- ensure the desired thickness distribution
- prevent rupture in the molding when hot.

Forming can take

- seconds, such as with thin PLEXIGLAS® sheets or EUROPLEX® films,
- minutes, such as with the usual processes in vacuum-forming machines or
- hours, such as with the retardation process, i.e., drape forming in a hot-air oven.

The recommended forming rate increases in the order PLEXIGLAS® GS to PLEXIGLAS® XT. If forming is relatively slow, it is advisable to continue heating the materials, such as with an infrared radiator.

When PLEXIGLAS® GS and XT are formed, the molecules orient themselves in the direction of stretching. This **change in structure** has a positive influence on the material behavior. The elongation at break of the

moldings increases in the stretched areas, and so do the impact strength, resistance to crack propagation, and—if only slightly—the crazing resistance.

The maximum **improvements** achievable with PLEXIGLAS® GS 233/OF00 are presented in Fig. 12.

5. Forming techniques

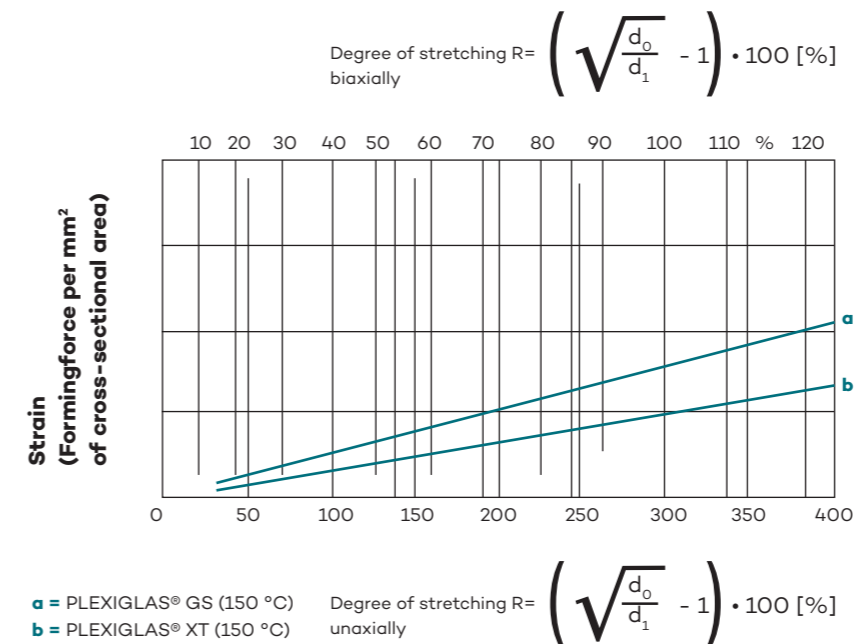

Fig. 11: Force requirement for uniaxial and biaxial stretching

PLEXIGLAS® GS 233/OF00				
Properties		Unstretched	Stretched 70% biaxially	Improvement factor
Elongation at break (+23 °C)	%	5,5	45	8
Crack propagation resistance	mm N/mm²	0,8	4	5
Impact strength, standard small test specimen	kJ/m²	12	30	2,5
Corrosion stress towards				
• isopropyl alcohol	MPa	11,5	32	2,1
• diethylene glycol	MPa	20	40	2

Fig. 12: Improvement of the mechanical properties by biaxial stretching

The continuously expanding fields of application for PLEXIGLAS® GS and PLEXIGLAS® XT have led to a wide variety of forming techniques by which the materials can be fabricated economically and in a manner suited to their nature.

The choice of technique depends on the following:

- size and shape of the workpiece
- required wall thickness distribution,
- number of units,
- material grade used,

- demands on the finished item in terms of appearance, dimensional stability, contour definition, etc.,
- available equipment, molds, and ancillary agents.

PLEXIGLAS® GS and XT can be formed by simple means and with good results if carefully handled. For complicated forming operations and long runs, the market offers a wide variety of machines, including computer-controlled forming stations.

The Association of German Engineers gives a summary of the basic forming techniques in its guideline 2008, sheet 1. The terms and definitions for the individual forming methods are in accordance with German industrial standard DIN 8580.

5.1 Forming by bending

Forming by bending means **straight-line bending**, angle bending, and drape forming, i.e., bending over positive (male) or into negative (female) molds. The main characteristic of this forming method is that the material thickness in the heated area is practically the same before and after forming.

For line bending, the simplest forming method, sheets of PLEXIGLAS® are heated linearly as described in section 3.2, then bent or curved and held in place until the parts have cooled down. Line bending is performed with the aid of a jig or over an edge. When bending over an edge, the material must be clamped on one side only, in order to avoid stretching and thus a pronounced thickness reduction in the bend area.

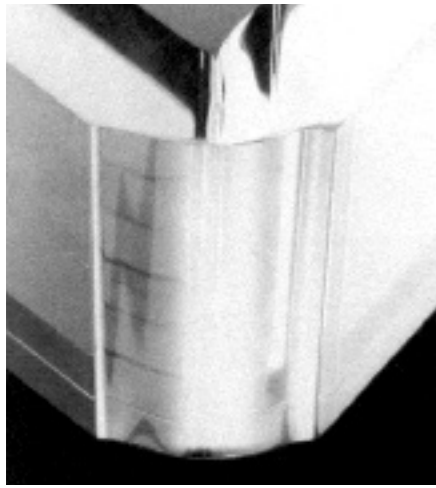

Fig. 13a: Stretching fault because heated area too narrow

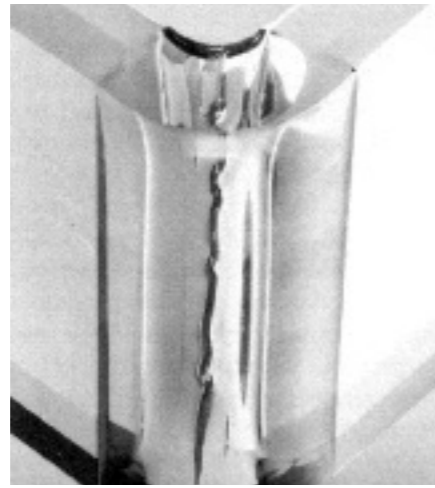

Fig. 13b: Creasing because bending radius too small

Moreover, the edge of the clamping device must be rounded in such a way that it does not touch the heated sheet area. Otherwise, unwanted mark-off will result (see Fig. 15).

The **bending radius** should be at least **twice the sheet thickness**. Smaller radii cause excessive stress or even creasing on the inside.

Optical distortion at the corners is the inevitable result of bending transparent plastics. The thicker the material and the smaller the bending radius, the more pronounced it becomes. In order to achieve good transparency in the formed area, the bending radius should therefore be as large as possible.

You can achieve special design effects with the glossy and smooth PLEXIGLAS® sheets, but also with **matte** sheets.

PLEXIGLAS® Satinice **SC** and **DC** keep their matte finish during almost all thermal forming, due to their cast structure. In contrast, the user can also find several applications for the extruded varieties. The burnished surface on PLEXIGLAS® Satinice, which comes from “within”, stays the same, while the embossed matte structure on PLEXIGLAS® Gallery **AR** can become glossy within the heating zone. All of this enables more creative design.

This behavior is true not only for line bending but for area-based thermal forming as well. The required bending angle, or radius, determines the **width of the heated area**. Normally it should be at least **three to five times the sheet thickness**. If the heated area is too narrow, the material may be overexpanded or stretched. The resultant thickness reduction impairs the optical quality

and reduces the strength of the formed item (see Figs. 13a and 13b).

A smooth transition in the blank avoids „expansion thresholds“. To achieve this, it is necessary to install a screen between the heat source and sheet (see Fig. 14).

In addition to the **recommended uniform transition between the heated and cold zones** of the blank, so that the bend **looks good**, there are other, contradictory requirements for the line-bent part. These can be influenced by the temperature curve within the support or clamping bars (on both sides of the heating wires) that are on some devices such as line benders.

If the design calls for a very **“tight” bend**, this is possible by strictly limiting the width of the heating zone,

where the **clamping bars are cooled** by cold-water flow (especially with large production runs). **Caution!** This can cause material stress and, in combination with solvents, cracks.

If the line-bent parts will later be bonded, the **clamping bars should be heated** instead to between 60 and 75°C, using heating rods in their cavities for example, **to avoid crazing**.

The elastic memory typical of all plastics has physical causes. Therefore, the bending angle—depending on forming technique—may change during or after cooling and deviate from the actual mold or desired shape. The change occurs in the direction of the sheet surface that retains the heat longest. This means that if the inside of the bend stays warm longer, the angle becomes smaller, and if it is the outside, the angle becomes larger. Since the material for the bending or cooling jig can influence the later contour definition of the line-bent part, care must be taken to compensate for such deviations (see “4” in Fig. 15).

The contour definition is improved by cooling both sheet surfaces at the same rate and time. This can be achieved, for example, by covering the parts with textile or foam material during cooling.

Heated parts formed to angles with short legs tend to warp in the bending axis while cooling down (**“sword effect”**). This is due to thermal expansion, shrinkage, and flexural strain in the bending area. Since these influences vary in intensity, the degree of warping also varies from case to case. The deviation from the straight line—which can be several millimeters per meter of length—can be offset by

- curving in the opposite direction on the bending jig and/or
- pre-heating the blank briefly in the oven at ca. 70 to 80°C for PLEXIGLAS® GS and XT; this reduces the stress generated in the bending area during the main heating process and thus minimizes the “sword effect”.

Sharp edges on the inside and a small outside radius are achieved by **grooved** bends, where a 90° **V-groove** is pre-cut along the bend line. After heating with a heating rod or heating wire, only the remaining sheet thickness will be bent. This procedure reduces the stability of the finished part, but it can be increased again by bonding the grooved bend afterwards.

A variation of this procedure (except with PLEXIGLAS® Resist sheets) is called **“break bending”** (see Fig. 16). First an elastic adhesive strip is applied, without bubbles or creases, to the back of the bend line. Then a V-groove of more than 90° is cut into the sheet down to ca. 0.3 mm and the sheet is broken towards the inside of the angle.

Thereafter, the parts are firmly held at the desired angle and the remaining gap is filled with ACRIFIX® 190 (adhesive from the line of ancillary agents). The flow of the adhesive can be improved by adding 3 to 5% THINNER 32. When the adhesive has set, the adhesive strip is removed and the outside edge given some light post-treatment if necessary.

This method comes very close to conventional bonding as described in Part 2, “Bonding”, in our Guidelines for Workshop Practice “Joining PLEXIGLAS®” brochure.

If the finished parts have a **very small cross-section**, it may be better to use suitable extruded profiles made from PLEXIGLAS® molding powder instead of bending sheet material.

Cold line-bending is not possible with acrylic glass. However, the highly impact-resistant PLEXIGLAS® Resist 75 or 100 grades can be “bent” cold with a radius exceeding twice the sheet thickness. This should be done only in exceptional cases, however, and is not recommended, since the mechanical and optical (white coloration) characteristics deteriorate as a result.

Sheets of PLEXIGLAS® GS and XT can, however, be **cold-curved** and installed while clamped in this pre-stressed state. In order to avoid excessive stress buildup, the following minimum radius must be observed for cold curving:

PLEXIGLAS® type	Minimum cold bending radius allowed (d = sheet thickness)
PLEXIGLAS® GS und XT (Including types with similar substrate such as Heatstop, Satinice, Soundstop etc.)	d x 330
PLEXIGLAS® Mirror XT	d x 330
PLEXIGLAS® Resist 45	d x 270
PLEXIGLAS® Resist 65	d x 210
PLEXIGLAS® Resist 75	d x 180
PLEXIGLAS® Resist 100	d x 150

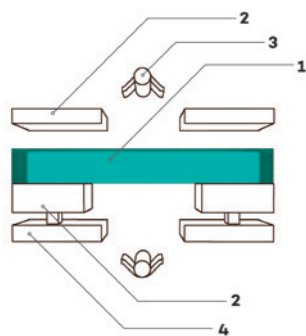

Fig. 14: Line-bend heating with screening: screen (2) between sheet (1) and IR radiator (3) above and below, support (4).

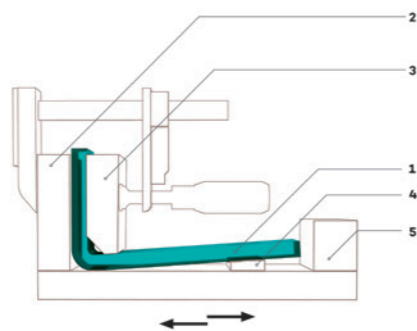

Fig. 15: Possibilities of correcting the bending angle: PLEXIGLAS® (1), bending jig (2); block beveled at its lower end (3), movable angle-adjustment device (4), stop (5).

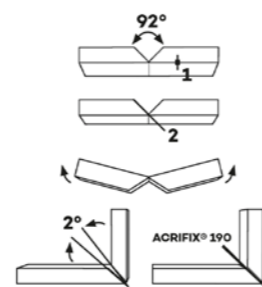

Fig. 16: Bending by breaking, ca. 0.3 mm (1), adhesive strip (2).

For **drape forming**, sheets of PLEXIGLAS® are heated in the oven or with infrared radiators (see 3.1 and 3.2) and then bent over male molds or into female ones (see Fig. 17). For this purpose, the molds must be covered with soft cloth such as glove-lining fabric, in order to rule out mark-off on the molding. Mark-off is also avoided if the heating or forming temperature is kept as "low" as possible, but this in turn may have an adverse effect on the contour definition of the finished item. Clamping strips or the like will help in this case.

Molds used for drape forming should always be preheated in order to prevent warping of the blank and ensure uniform cooling. The latter will also be promoted by covering the exposed sheet surface with textile or foam material.

Drape forming is mostly used for uniaxial curving of cylindrical shapes, in exceptional cases also for gently

curved spherical shapes. To hold down the blank, a clamping frame can be used that covers the entire edge of the sheet and avoids creasing.

Where the elastic memory of the plastic makes it difficult to achieve a high contour definition with male (convex) molds, better results can be obtained with female (concave) molds without great effort.

If distributors are unable to supply tubes of PLEXIGLAS® GS and XT in the required dimensions, it is possible to **form tubes** from sheet material. This also applies to conical tubes of these grades. Since heating the sheet results in shrinkage – due to physical reasons – it is advisable to conduct a tube-forming test beforehand.

Caution: In the case of extruded PMMA such as PLEXIGLAS® XT, the heat-induced shrinkage varies in length and width (see Fig. 2).

When forming tubes, it should be remembered that they bulge somewhat at the ends, so that the finished tube must be shortened accordingly to keep the walls straight. This means that the initial blank should be somewhat longer than will be needed later.

In practice, it is difficult to predict the effects of heat and shrinkage on the desired tube diameter and therefore to bevel the edges of the sheet beforehand to obtain the V-groove required for subsequent bonding. Instead, the size of the blank should be such that the ends overlap beyond the desired tube diameter. After cooling, a dividing cut is performed and the seam is then bonded.

Fig. 18 shows the forming of a heated blank by rolling it over a mandrel covered with cloth. This method has the advantage that the final shape is achieved in a single heating and rolling step.

Where this is impossible for reasons of size or existing equipment, another technique can be used, which is shown in Fig. 19. It is suitable for cylindrical and conical (hollow cone) shapes. In this case, the blank that is to form the hollow cone is heated in the oven and the two seam edges are clamped together at the same level without overlapping.

If necessary, the seams can be improved by a corrective cut after cooling to ensure a clean bond. Gap-filling reaction adhesives – such as ACRIFIX® 190 – should be used for bonding.

For detailed information on bonding, see our Guidelines for Workshop Practice "Joining PLEXIGLAS®"-brochure.

In order to achieve the maximum ultimate joint strength, improve the long-term behavior of the cured adhesive and prevent possible bubble formation during subsequent reheating, the workpiece should be annealed (see the Guidelines for Workshop Practice "Machining PLEXIGLAS®" brochure under "8 Annealing").

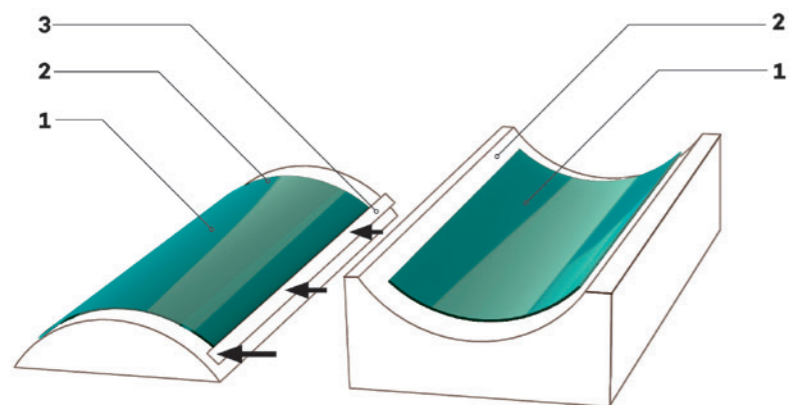

Fig. 17: Drape forming: PLEXIGLAS® sheet (1), mold covered with cloth (2), clamping strip (3)

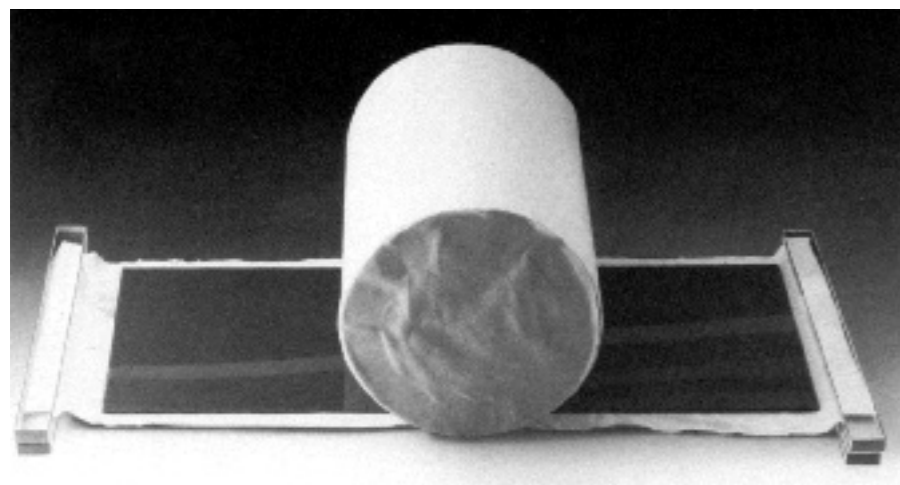

Fig. 18: Forming a sheet into a tube by rolling

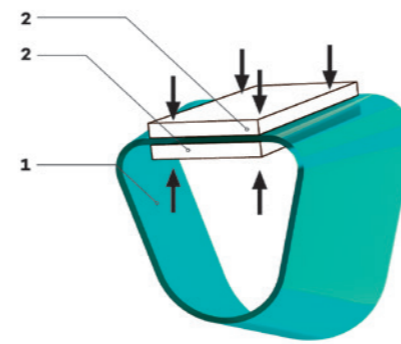

Fig. 19: Pre-forming of a hollow cone, PLEXIGLAS® GS (1), clamping blocks (2).

During subsequent reheating to the forming temperature in the oven, the material's elastic memory causes it to assume more or less the desired tube shape – very noticeable with PLEXIGLAS® GS, to a lesser extent with PLEXIGLAS® XT. Different ways of handling tubes during oven heating are described in section 5.7 'Thermoforming tubes and rods'.

5.2 Pressure forming

Pressure forming is a purely mechanical procedure and particularly recommended where

- the production run (number of units) is not large enough to justify injection molding or
- high-molecular-weight PLEXIGLAS® GS is required.

Embossing is a particularly important method for forming PLEXIGLAS® GS and XT under pressure. Typical in this case are the relatively high pressures, which depend on the profile to be embossed, the shape of the embossing tool, and the percentage of material volume to be displaced during embossing. Also to be considered is the resistance to forming presented by the material in question, which is lower for PLEXIGLAS® XT and greater for PLEXIGLAS® GS.

Prior to the actual forming process, it is common practice to heat the PLEXIGLAS® blank and mold to the forming temperature in order to avoid premature cooling during embossing. Especially when processing optical parts, it is advisable to use steels that can be satisfactorily polished for the embossing tools. It is also important that air from the deepest areas of the die be able to escape from the molds.

Cooling should occur uniformly from all sides in order to avoid warping or excessive material stress. Due to the low thermal conductivity of plastics, thick-walled items cool down fairly slowly. In order to save time and make more effective use of the press, several lockable molds or multi-cavity molds should be used.

A variant of the process is **embossing letters or symbols**, especially on

flat surfaces. To this end, the embossing die is heated above the forming temperature and pressed into the „cold“ material.

A special technique for high-definition embossing of letters, for example, is pressure forming of heated blanks using a **silicone rubber sheet** (Shore hardness A 60) that is twice as thick as the embossing depth, into a negative metal mold (see Fig. 20).

Further possibilities of shaping the surfaces of finished items by embossing are opened up by the use of

- textured, perforated, or similar types of sheet metal as embossing tools,
- rigid-foam materials, such as ROHACELL®, as linings in mold walls and with flexible foams (such as polyurethane or polyether), also using a silicone rubber sheet as for embossing,
- other materials such as wood, textiles, etc.



Fig. 20: PLEXIGLAS® GS letters pressure-formed using an aluminum mold and silicone rubber sheet

5.3 Slip-pressure forming

In this case, PLEXIGLAS® GS and XT are heated and then formed by means of a plug or male die, with or without the use of a female mold. In contrast to the methods described so far, however, the sheets are not firmly clamped but rather held by a **spring-loaded** „hold-down“ ring and can therefore slip inwards, so that stretching occurs in both the exposed and clamped sheet areas. Given adequately heated tools (ca. 100°C), formed items of more or less uniform wall thickness will be obtained. The process makes mark-off unavoidable.

Fig. 21 shows the method used for rotationally symmetric moldings. Mark-off, if any, will normally be on the inside. In order to **reduce plug mark-off**, the plug surface should be neither rough nor highly polished, but instead have a satin finish.

In certain instances, slip-pressure forming is followed by **blow molding** of the drawn-in material into a negative mold with the hold-down ring **locked**. The aforementioned mold marks are then mainly on the outside.

5.4 Stretch forming

This group of techniques for PLEXIGLAS® GS and XT uses plug pressure, compressed air, or a vacuum. Here, the sheets are formed with or without a counter mold. As opposed to slip-pressure forming, where the material is loosely held by the spring-loaded hold-down ring, stretch forming is performed with the sheet **firmly clamped**. Only the exposed area is formed. Depending on the shape of the finished part, **the material thickness decreases** throughout or in certain areas only.

The load-bearing capacity of the finished item therefore depends on the strength of the thinnest point and the remainder of the item is overdimensioned. This drawback can be eliminated by **plug-assist or air-pressure pre-stretching**, in which case thinner sheets can be used initially. Since near-identical wall thicknesses result in near-identical degrees of stretching, the material structure is more or less uniform. As a result, the formed item has similar

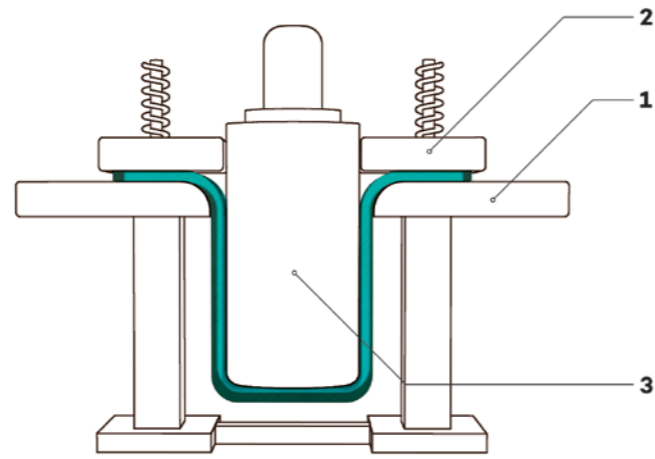

Fig 21: Slip-pressure forming without a female mold; spring-loaded hold-down ring (1), clamping ring (2), plug (3).

strength characteristics throughout (see the structure-change discussion under 4.1, 'Conditions and behavior').

Forming with **combined** techniques is variable, for example to intentionally increase the wall thickness in those areas of the finished item that will be more highly stressed in use. These techniques generally combine vacuum and air-pressure forming with plug-assisted forming. Here, a heated blank is pre-stretched mechanically and formed to its final shape with a vacuum or air pressure. All of these combined techniques, which are commonly performed on vacuum-forming machines, are described in detail in the following.

Whether forming is performed mechanically, by blowing, or by applying a vacuum depends on the type of finished article and the desired surface quality. Plug-assist stretching is only possible if the formed item should not exhibit differences in cross-section, whereas air-pressure stretching also is suitable for complex shapes and for parts with or without undercut

Whether compressed air or vacuum is used for thermoforming of the heated blank depends on the desired result. Vacuum-forming has its limits, because the maximum available pressure for forming work is just under 1 bar. This is not always enough for high-definition forming of PLEXIGLAS® GS finished articles. Optimum vacuum-forming is therefore only possible with PLEXIGLAS®

XT types and certain special grades. In most other cases, compressed-air techniques are preferred, because they enable higher forming forces and thus better forming results.

In **plug-and-ring forming** the heated blank is formed by means of a plug or die passing through a clamping ring or contour plate, or it is drawn over a male mold while clamped in a frame. If the forming plug or die is „cold“, the area it touches first cools down and can then no longer be stretched to any measurable degree. This results in formed items with thick bases and relatively thin walls, since stretching occurs practically only in the walls. This effect can be further enhanced by using a spring-loaded counter-plug.

More uniform wall thickness distribution is achieved by heating the plug to the forming temperature: pronounced cooling is avoided, and the material can slide over the edge of the plug, so that stretching is not confined to the lateral areas. In order to enable it to slide uniformly, the contact edges of the forming plug or die should be well-rounded and treated with mold grease, silicone oil, talcum, or PTFE spray.

When using undercut plugs, it should be remembered that the lower portion of the lateral surface will be distinctly curved and that this curvature will only change into a cone as the depth of draw increases. Where a linear cone base is required, a solid plug must be used that allows the material to nestle against it (Fig. 22).

If a solid plug is used, mark-off on the formed item is usually unavoidable and most noticeable in transparent material grades. Therefore, it is often advisable to use a skeleton plug (see 7.1) instead of a solid one to avoid such mark-off.

In **free blowing or vacuum-forming without a counter mold**, the clamped heated blank is either blown into the open through a clamping ring or frame, or drawn into a mold box under vacuum (Fig. 23).

The formed items are of good optical quality because the material surface does not touch any mold wall, so that marking and localized cooling are prevented. Using this technique, it is possible to form parts with domed surfaces whose shape adapts more or less directly to the geometry of the clamping frame. Fig. 24 shows plan views of selected shapes.

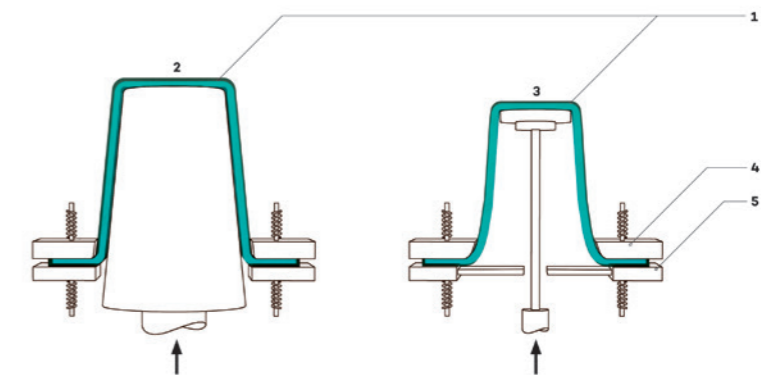

Fig. 22: Thermoforming with undercut and solid plug, respectively; PLEXIGLAS® (1), solid plug (2), undercut plug (3), clamping ring (4), hold-down ring (5).

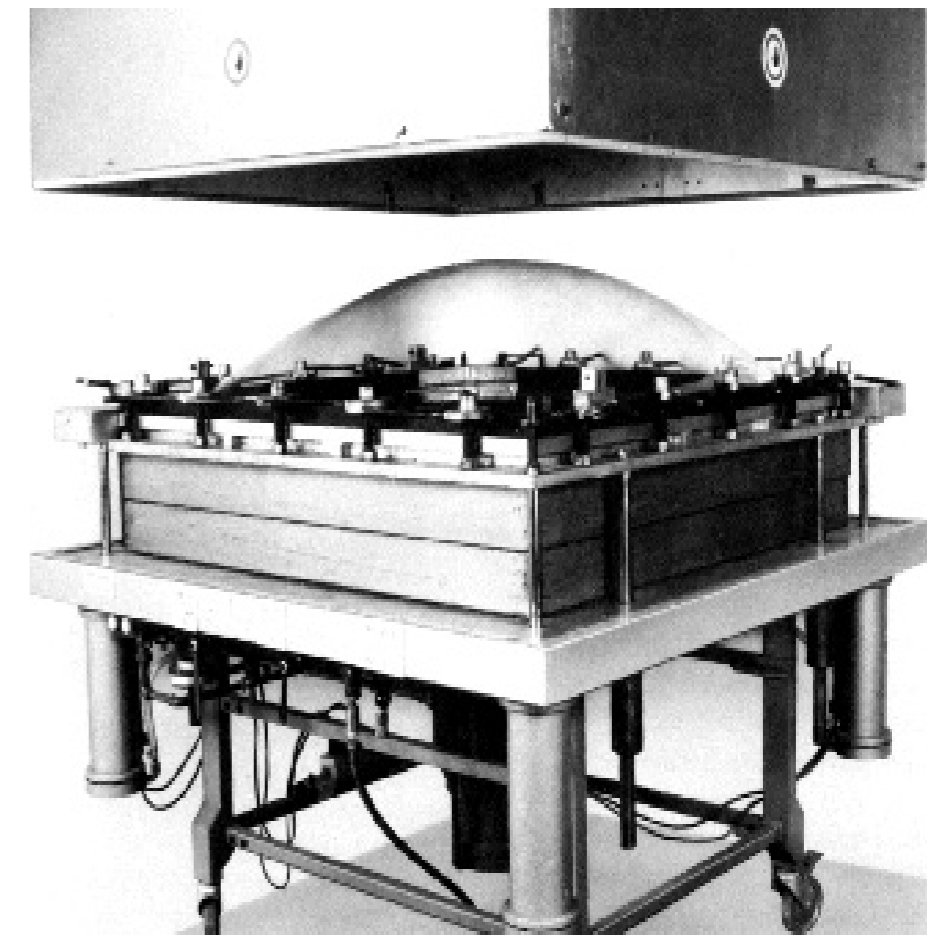

Fig. 23: Blow forming of a domed skylight without a counter mold

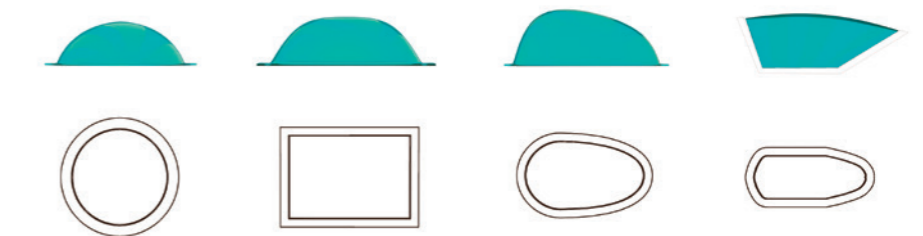

Fig. 24: Examples of plan-view shapes and the resulting side contours.

Varying the air pressure or vacuum will produce the desired height or depth. To determine the height, use a jig made of soft, heat-insulating material, which rules out optical distortions in the formed item. Alternatively, the air pressure or vacuum can be controlled automatically by means of optical light sensors or proximity switches that check the air supply via a solenoid valve. Although this method is somewhat more expensive, the absence of contact is an advantage that outweighs the initial cost, especially with large production runs.

If the evenly heated blank is formed as described, the thickness distribution is inversely proportional to the depth of draw. Fig. 25 illustrates this relationship by the example of a free-blown hemisphere with the following dimensions:

Sheet thickness $s_1 = 8 \text{ mm}$
Dome diameter $d = 1000 \text{ mm}$
Dome rise $h = 350 \text{ mm}$

The thickness at the crown can be calculated as follows. From the rise and diameter of the dome, we calculate the ratio $h/d = 0.35$. Then we move from this value on the h/d -axis horizontally to the intersection with the curve and drop a perpendicular onto the s_2/s_1 -axis. There we obtain the ratio $s_2/s_1 = 0.55$. Insertion of the initial sheet thickness $s_1 = 8 \text{ mm}$ results in a crown thickness $s_2 = 4.4 \text{ mm}$.

The dimensional accuracy or contour definition and the reproducibility of free blowing or vacuum-forming without the use of a counter mold are adequate for most applications, such as the manufacture of domed roof lights. This is particularly so if the clamping edge is later used for installation. The forming tools can be relatively simple in design.

For blowing, use a stable base plate with clamping frame. Good sealing is ensured by a beaded clamping frame. For clamping the hot sheets, use mechanical or pneumatic toggle clamps. Their number depends on the size of the item to be produced, the rigidity of the clamping frame, the total pressure required, and the loading capacities of the individual clamps.

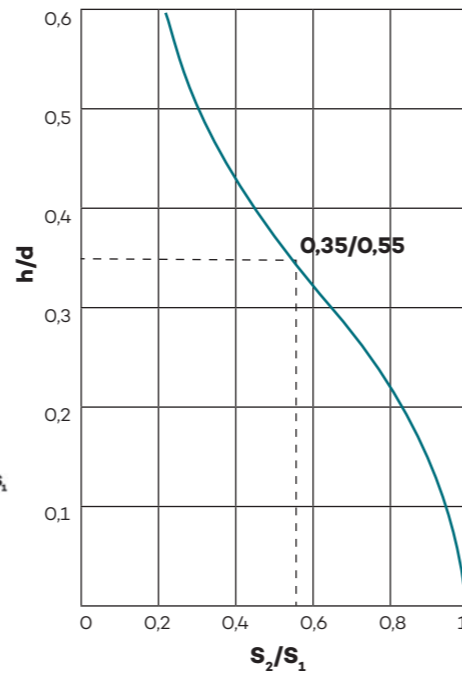
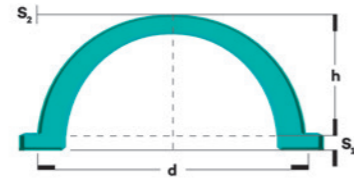

Fig. 25: Thickness distribution of a blow-formed hemisphere

A practical example: Consider an “ordinary” 3 to 6 mm thick light dome of PLEXIGLAS® XT. The conditions are approximately as follows:

- Dome rise:** ca. 25 % of the net width or net diameter at the dome base
- Degree of stretching:** ca. 16 %, biaxially at the vertex
- Material thickness:** ca. 75 % at the vertex compared with the original thickness
- Heating temperature:** 150 to 160 °C in an airflow oven or for infrared heating

Since the short-term pressures that build up between the blow-forming table and dome shell are only ca. 0.01 to 0.03 MPa, the upper clamping ring is safe against ‘blow-off’ if its clamping pressure is based on a blowing pressure of ca. 0.05 MPa (0.5 kgf/cm²).

For a given nominal size of the dome or mold, the retaining force of the mechanical or pneumatic clamps in the worst case—a dome with a

flat edge, for example—is calculated according to the formula:

$$F_H = \frac{P_{\max} \cdot A \cdot L \cdot 1000}{U_K}$$

- F_H = force per clamp (N)
- P_{\max} = max. blowing pressure (MPa)
- A = nominal area (m²)
- U_K = dome circumference (m)
- L = clamp spacing (mm)

Example: A light dome 2000 x 1000 mm in size has a nominal area of 2 m² and a circumference of 6 m.

This results in the recommendation that clamps with a force of ca. 7.5 kN = 7500 N = 750 kgf each be provided approx. every 450 mm. (For suitably designing clamp-attachment areas, see 7.2.)

For blow-forming, it is important to ensure that the incoming compressed air does not immediately hit the hot blank, resulting in localized cooling and in turn optical as well as physical distortions. To prevent this from happening, deflect or distribute the air current with baffles, screens, or layers of fabric over the inlet opening.

Placing the heated sheet on a cold base plate may cause undesired cooling. Therefore, heat the plate beforehand or cover it with cloth or insulating material such as foam.

When **vacuum-forming**, position the vacuum holes in the box evenly around the edge to prevent air currents from cooling one side only. For forming large parts, fit a reservoir before the vacuum pump for quick evacuation of large volumes of air.

Blowing and vacuum-forming with female molds provides moldings with varying wall thicknesses. Depending on the shape of the mold, part of the heated material will quickly touch the mold wall, cool down and then not be stretched further. In this case only the exposed parts can be formed. Given extreme undercuts or convex areas, these locations may be stretched excessively, with the walls becoming very thin. This is illustrated in Fig. 26 by the example of the wall thickness distribution in a blow-formed lighting cover with undercuts, made of PLEXIGLAS® GS or XT.

The highest degrees of stretching are found in the areas farthest from the center of the flat unformed blank.

Uniform wall thickness can also be achieved by controlled localized cooling of the most highly stretched portions. This requires great skill, however. High-definition forming of corners, on the other hand, is not possible unless special tools are used that permit pressures of up to 15 bar. Given such high forces, hydraulic presses are needed to seal the molds reliably. The necessary press capacity can be calculated via the required locking force, as the product of the base area and the specific blowing-air pressure.

For this technique, the molds should be made of cast aluminum or steel and designed with an adequate, verified safety margin. Install relief valves to prevent overloading, and provide air ducts or vent holes at extreme points to assure high-definition forming. We recommend that you mount the cover or base plate on the lower platen and the mold on the upper platen. This prevents contamination and sagging of the heated blank into the mold.

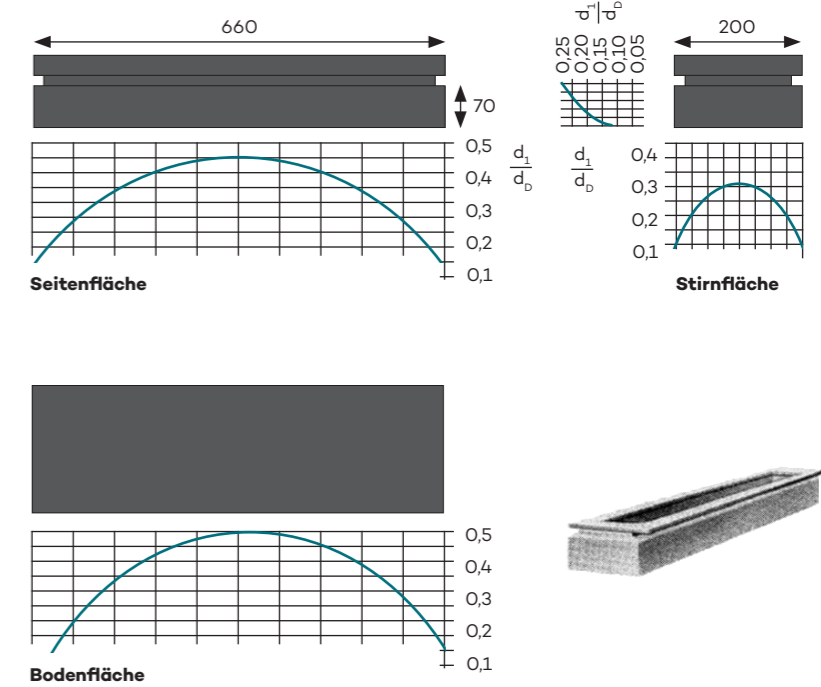

Fig. 26: Thickness distribution on a blow-formed, undercut lighting cover made of PLEXIGLAS® GS or XT (d_0 = original thickness, d_1 = final thickness).

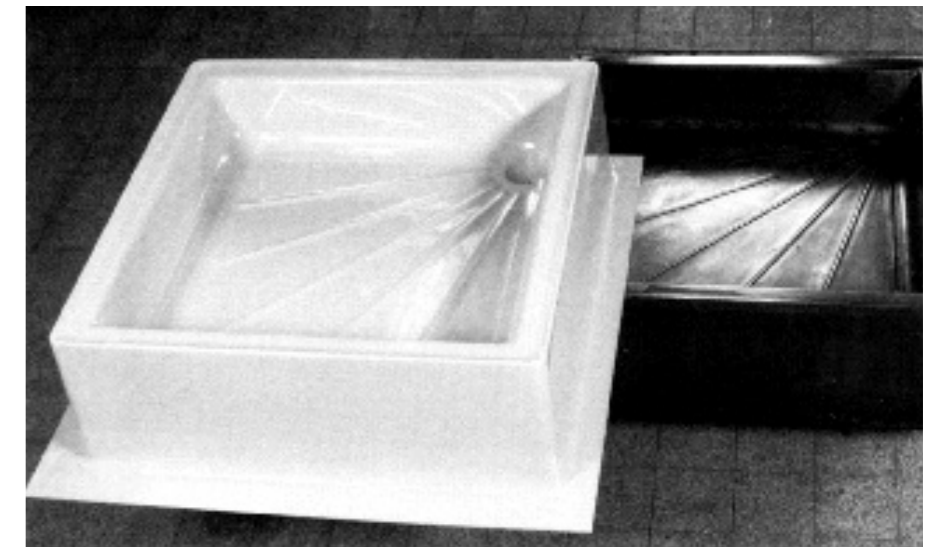

Fig. 27: Shower base; male mold, and molding

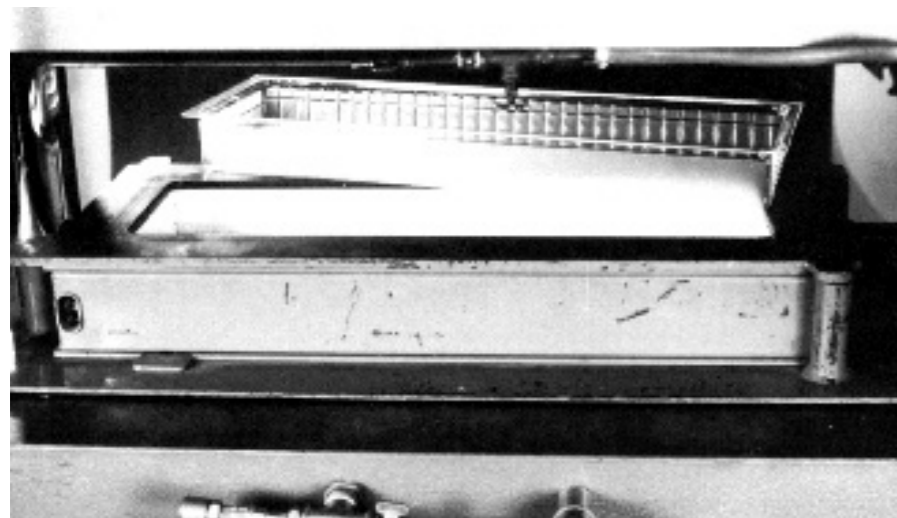

Fig. 28: Striplight cover; female mold, and molding

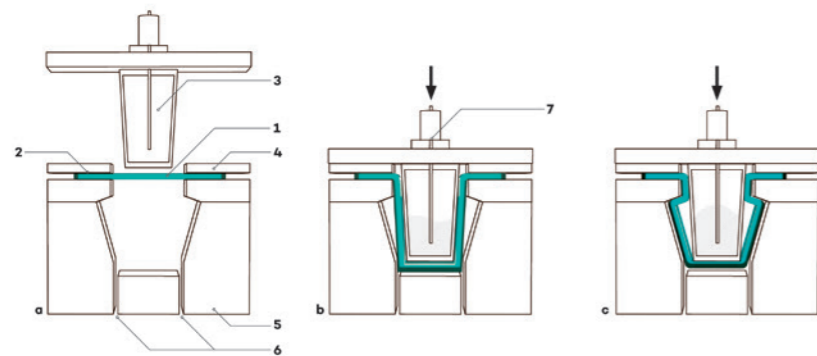

Fig. 29: Blowing into a female mold with mechanical pre-stretching. PLEXIGLAS® (1), sealing edge (2), plug (3), clamping frame (4), female mold (5), venting ducts (6), compressed air inlet (7).

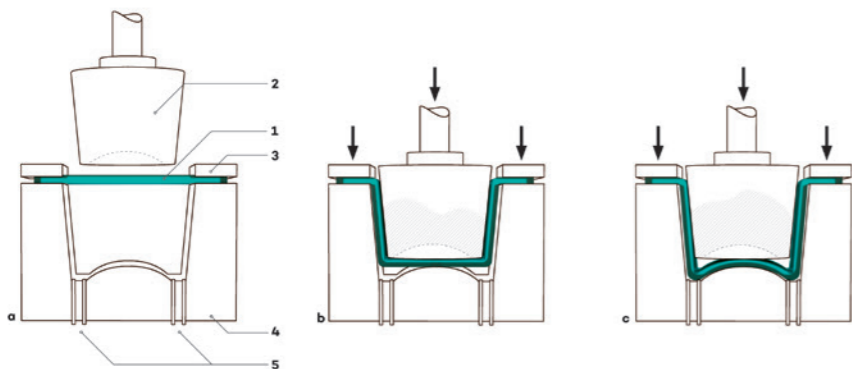

Fig. 30: Vacuum-forming into a female mold with mechanical pre-stretching. PLEXIGLAS® (1), plug (2), clamping frame (3), female mold (4), suction ducts (5).

As a general rule for **thermoforming with positive (male) or negative (female) molds**, the positive mold has the same shape as the finished item, whereas the negative mold is a 'casting' of the latter (see Figs. 27 and 28).

Vacuum-forming in a negative mold differs only slightly from blow molding as described above. The base

plate can be replaced by a clamping ring or frame in this case. Less force is needed for the mold and clamps, so that the use of a hydraulic press is not essential. Like the vent holes for blow forming, the suction holes for vacuum-forming must be located at the most distant points. Vacuum-forming offers another technical advantage over blow forming: since practically the whole cross-section

to be formed is exposed, the clamped sheet can be heated by infrared radiation. This is normally done with heating panels that can be positioned over the mold or forming station. If a negative mold is used, its contours are accurately reproduced, but mark-off occurs on the serviceable side of the molding.

Blowing into a female mold with mechanical pre-stretching has the advantage of permitting the production of undercut moldings (Fig. 29). Where particularly high stretch ratios are to be achieved, the heated material can be allowed to slip through a spring-loaded hold-down ring during pre-stretching, as described under 5.3, 'Slip-pressure forming'. The heated sheet material is pre-stretched by the plug and then brought into its final shape by air pressure. In this process the sides are stretched first and only then the remaining portions that were against the plug. In this way, it is possible to achieve a near-uniform wall thickness. The thickness distribution depends on the pre-stretching effected by the plug. The entire forming equipment, and in particular the plug, must be pre-heated well in order not to cause any disturbances due to cooling.

Blow forming into a female mold with mechanical pre-stretching occurs as follows (Fig. 29):

- starting position
- mechanical pre-stretching
- final forming with compressed air

in the following sequence:

- heating the PLEXIGLAS® blank
- placing it over the mold and clamping it with a rigid or spring-loaded hold-down ring
- pre-stretching and, when pre-stretching is completed, locking of the mold with the hold-down ring
- final forming with compressed air
- cooling to ca. 60 to 70°C
- removal from the mold

Vacuum-forming into a female mold with mechanical pre-stretching is essentially the same as blow forming. However, the smaller available pressure difference of at most 1 bar restricts the applicability of this technique to simple items with no major undercuts.

Fig. 30 shows the procedure:

- starting position
- mechanical pre-stretching
- final forming by suction (vacuum)

Blowing and vacuum-forming with male molds are carried out by the same technique as forming in female molds. In this case, however, the 'replica' of the mold is on the inner surface of the workpiece, and no marking occurs on its serviceable side. The thinnest portions usually form at the flat surfaces and sides of the molding, whereas with female molds they usually occur at the edges. The best suitable forming technique depends on the requirements to be met by the molding and must be selected from case to case.

Compared to stretch-forming techniques using female molds, **vacuum-forming onto a male mold with mechanical pre-stretching** has the advantage that the mold also serves as the pre-stretching plug. Moreover, marks appear on only one surface.

Fig. 31 shows the procedure:

- starting position
- mechanical pre-stretching
- final forming by suction (vacuum)

Where a vacuum provides insufficient force, the forming can also be done with compressed air. In either case, heat the molds well (see 2.1) and provide suction or vent ducts at the right points in the mold.

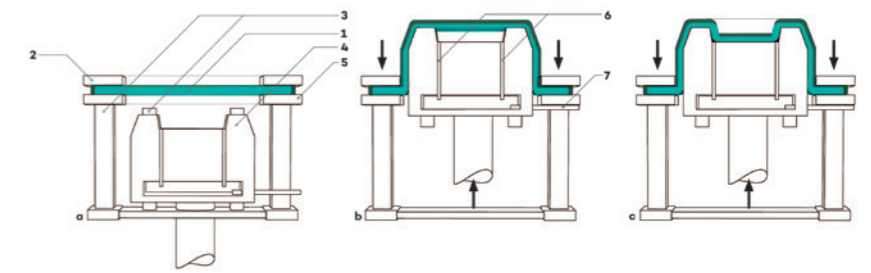

Fig. 31: Vacuum-forming onto a male mold with mechanical pre-stretching. PLEXIGLAS® (1), clamping frame (2), supporting tubes (3), male mold (4), mold frame (5), suction ducts (6), vacuum connection (7).

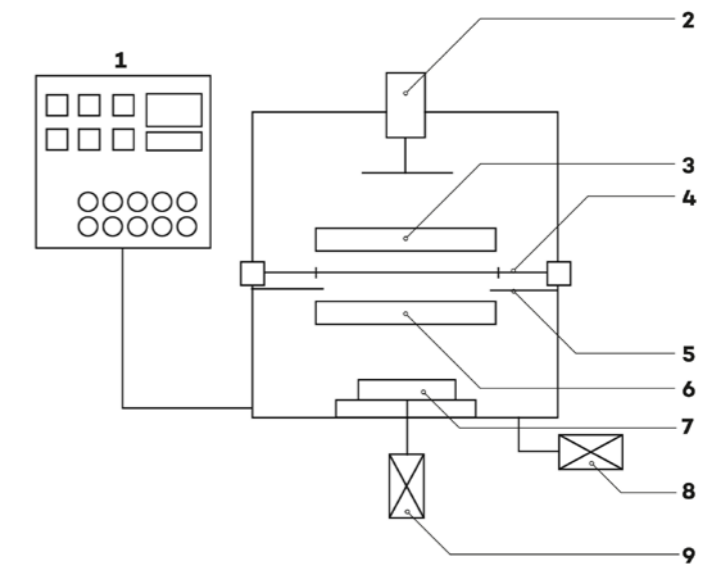

Fig. 32: Schematic of a vacuum-forming machine: control box (1), plug assist ram (2), top heater (3), clamping frame (4), window sheet (5), lower heater (6), mold table with mold (7), compressed air (8), vacuum (9).

	Vacuum-forming machine	Separate forming station
Pros	<ul style="list-style-type: none"> Top and bottom heating Very versatile Controllable sequence of operations Accurately regulated temperatures Short cycle times Automatic feed or ejection possible 	<ul style="list-style-type: none"> Moderate initial investment Do-it-yourself construction possible Adaptable to the respective job
Cons	<ul style="list-style-type: none"> High initial investment Longer downtimes in case of frequent mold changes 	<ul style="list-style-type: none"> Usually a small selection of molds Manual operation or low degree of automation Usually only top heating or none at all (separate)

Fig. 33: Comparison of vacuum-forming machine vs. forming station

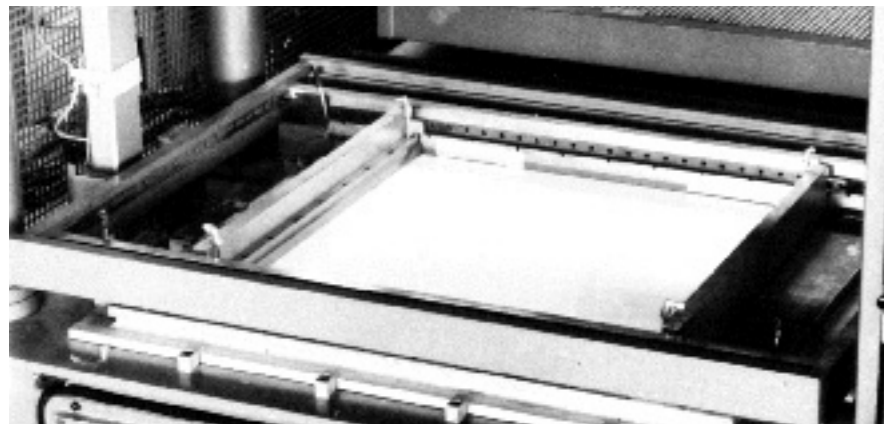
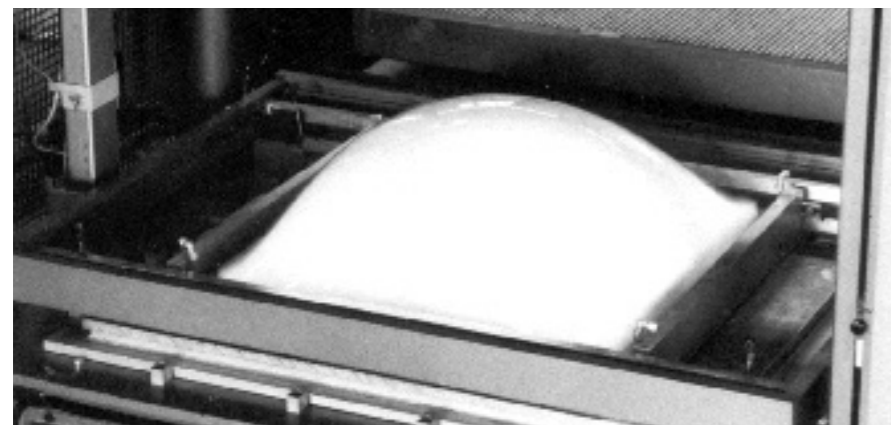

Fig. 34: Thermoforming a shower basin on a vacuum-forming machine
a: Clamped blank of PLEXIGLAS® GS SW



b: Blank being pre-blown



c: After vacuum-forming

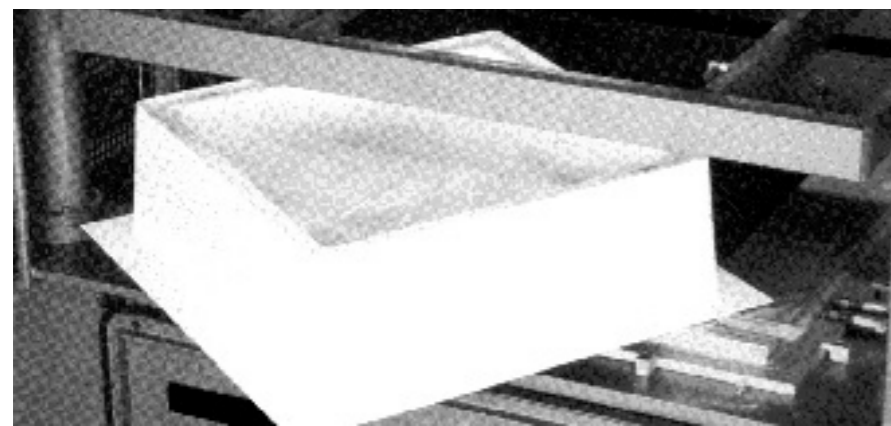

d: Removal of the molding

5.5 Thermoforming on vacuum-forming machines

All forming techniques with pre-stretching described above for PLEXIGLAS® GS and PLEXIGLAS® XT can be performed on so-called **thermoforming or vacuum-forming machines**. Unlike separate forming stations, vacuum-forming machines are universally applicable and have the advantage that all operations can usually be automated, so that perfectly identical molded products are obtained.

Nearly all vacuum-forming machines are equipped for heating from above and usually from below as well. The infrared heaters are adjusted to the required output via a control box, either individually or in groups, and the temperature distribution on the sheet is adapted to the geometry of the mold. Depending on the design, the sheet surface temperature can be measured with a contact-free IR-radiation pyrometer, which is usually installed in the top heater. If this device is not available, the sheet temperature must be controlled via the heating period.

Fig. 32 shows the structural principle of a vacuum-forming machine (and its pros and cons are summarized in Fig. 33).

Using the compressed-air connection, the heated sheet can be pre-blown, if needed, like a balloon before the mold table and mold move up into this bubble. This creates a more uniform thickness, particularly in the case of tall molds. The height of the bubble is the same with every forming operation, thanks to the automatic control. The final forming is performed by a vacuum.

The plug-assist ram can also

- serve as a tool holder,
- accommodate mechanical pre-stretching devices (such as a baffle plate)
- or be provided with additional postforming tools, such as for stamping the article from above.

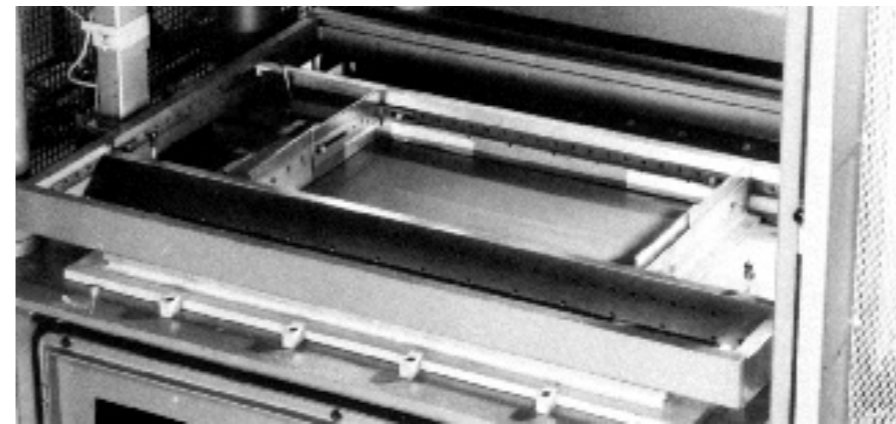
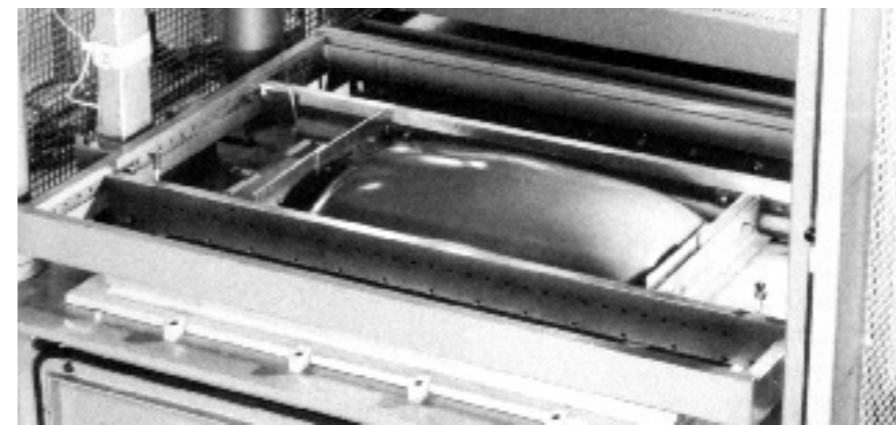
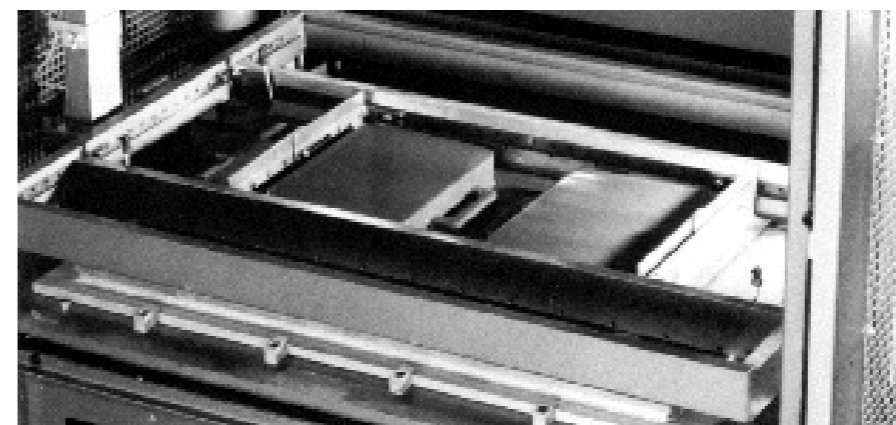

Fig. 35: Thermoforming suitcase components on a vacuum-forming machine
a: Clamped blank of PLEXIGLAS® XT



b: Blowing



c: After vacuum-forming

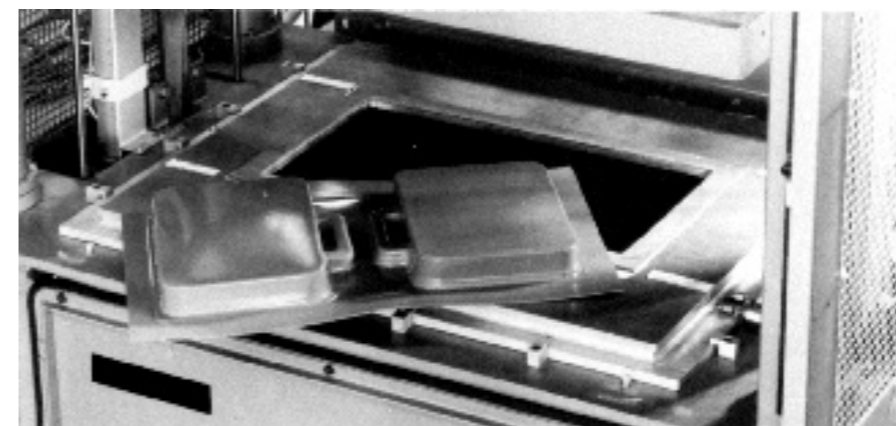

d: Removal of the molding

Using the control functions, the cycle timing and sequence of operations can be automated to assure reproducible

- heating times and forming temperatures,
- pre-stretching with air (bubble height),
- vacuum delay,
- vacuum duration,
- cooling times
- mold release procedures.

Figs. 34, 35, and 36 show as examples of this common technique the thermoforming of solid flat sheets of PLEXIGLAS® GS SW (shower basin), PLEXIGLAS® XT (suitcase), and PLEXIGLAS® Resist (wall box) on a vacuum-forming machine.

In certain cases, such as when forming complex shapes, it is practical to use a „baffle plate“ attached to the plug-assist ram of the vacuum-forming machine (Röhm Patent No. DE-A 3516467). This limits the height of the air bubble and flattens it, so that the mold can be raised into it more easily and better wall thickness distribution of the formed article is ensured (see Fig. 37).

Vacuum-forming machines provided with a **twin-step clamping system** (Röhm Patent No. DE 3410550C 2) and a **thermostatically controlled clamping frame** offer yet another advantage. They guarantee a warp-free clamped edge when producing formed items.

In conventional thermoforming, the clamped edge of the formed article may warp beyond control during cooling. The causes of such warpage are temperature differences between the clamped portions and the exposed area of the blank as well as the restricted thermal expansion and contraction.

The twin-step clamping system, on the other hand, permits largely unhindered thermal expansion of the clamping frame, because at the start of heating—the first step—the blank is only loosely held by the clamping

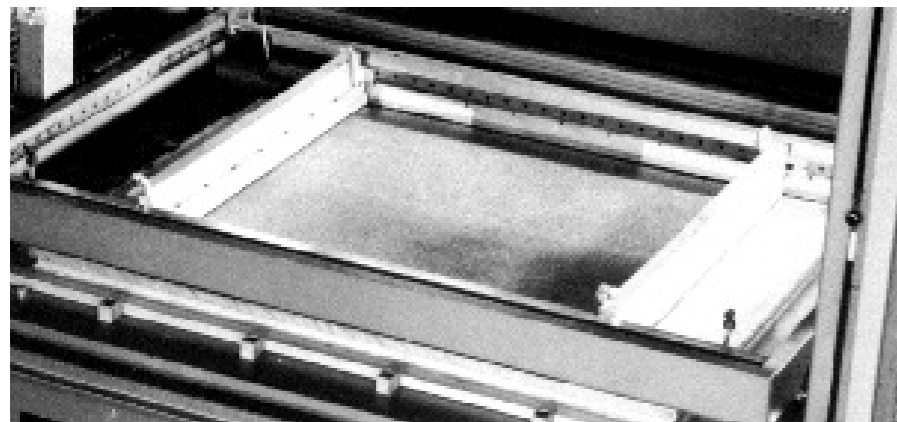

Fig. 36: Thermofforming a wall box on a vacuum-forming machine
a: Clamped blank of PLEXIGLAS® Resist

frame. At the same time, the thermostatically controlled clamping frame warms up the clamped edge, thereby reducing the temperature difference to the exposed sheet area heated by the IR radiators. The second step—firm clamping—does not occur until the blank is more or less relaxed, just before it reaches its softening temperature.

The following temperatures have proven suitable for the clamping frame:

PLEXIGLAS® GS: 80 °C
PLEXIGLAS® XT: 75 °C

5.6 Thermofforming on presses

Presses are common as separate forming stations for PLEXIGLAS® GS and PLEXIGLAS® XT. The blanks formed on them have usually been pre-heated in other locations.

Especially for forming large parts and at high blowing pressures, substantial clamping and forming forces may be required that vacuum-forming machines might not achieve. This then is a reason for using presses of corresponding capacity. They will normally operate hydraulically, but sometimes also mechanically, and be universally applicable, i.e., permit the use of a wide variety of molds. They are particularly suitable for frequently changing programs and techniques, and unlike vacuum-forming machines can handle blanks of any given size. Further advantages of hydraulic presses result from the type of construction:

- moving lower platen with high pressures,
- moving upper platen for high pressures,
- pneumatic or hydraulic ram at lower and/or upper platen,
- additional compressed air and/or vacuum connection to lower and/or upper platen,
- possibility of heating in the press by a movable or vertically swiveling infrared heating panel,

separable platens, i.e., the individual parts can be operated separately, or jointly after being locked.

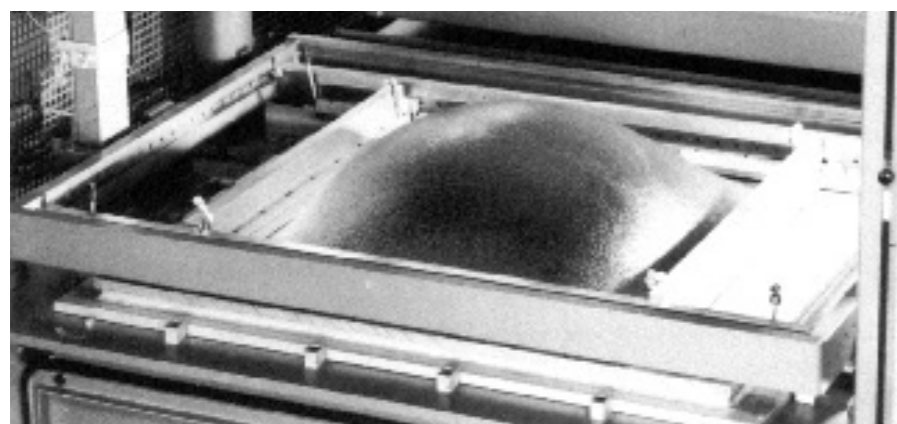

b: Pre-blowing

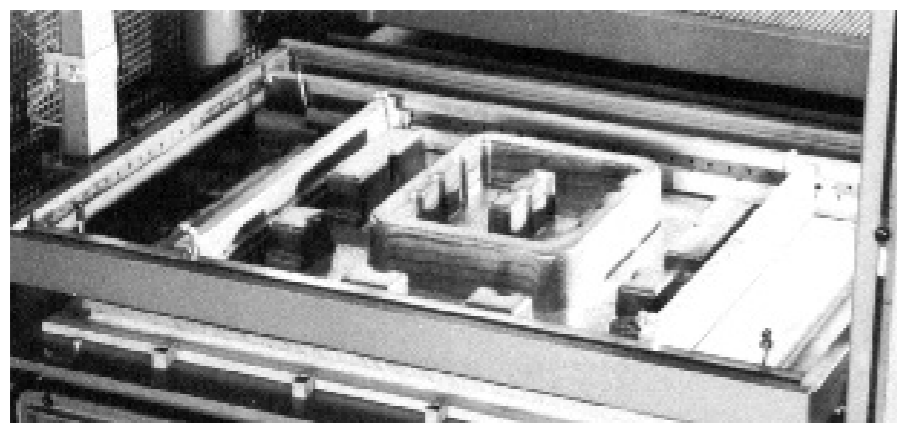

c: After vacuum-forming



d: Removal of the molding

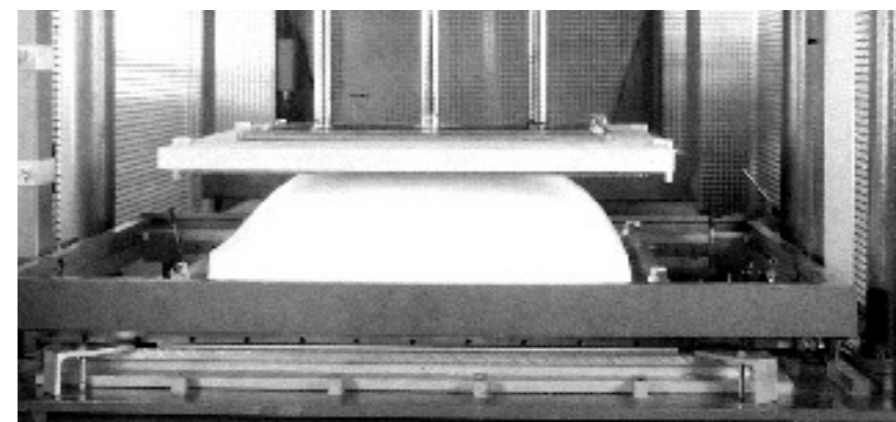

Fig. 37: Pre-blowing against a baffle plate

The maximum force of the press depends on the size of the part to be formed and the forming technique. At a platen size of 3000 x 1000 mm, for example, it is between 1000 and 2000 kN. The intensity of the pressure should be automatically controlled by means of a pressure limiter (high-pressure contact switch). A two-stage hydraulic system is recommended for fast forming. The low-pressure stage will then ensure quick locking of the press, and the second stage will provide the required clamping and forming pressures. Automated forming should be an option for large runs.

Unless forming occurs exclusively by compressed air, additional hydraulic tools are required besides the hydraulic platen. They can be mounted on either the lower or upper platen.

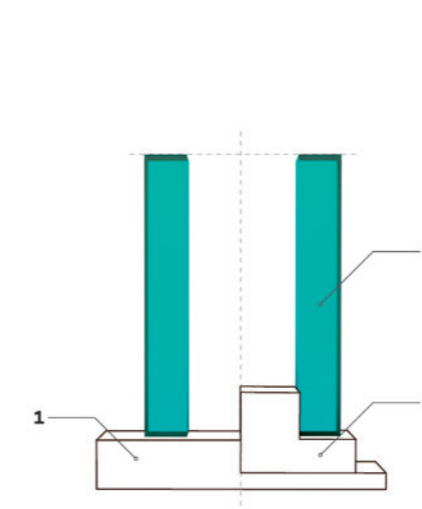

Fig. 38: Heating in an upright position: support (1), PLEXIGLAS® tube (2), centering plug (3).

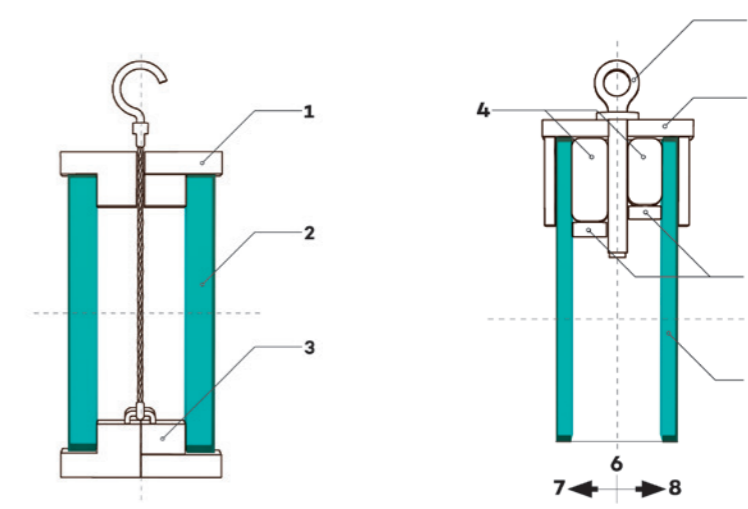

Fig. 39: Suspended heating of tubes by means of centering discs: drilled disc, loose (1), PLEXIGLAS® tube (2), centering disc with suspension attached (3).

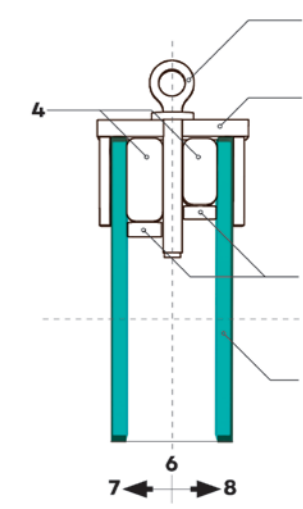

Fig. 40: Suspended heating of tubes with holding collar: threaded eye-bolt (1), PLEXIGLAS® tube (2), bell-shaped holding collar (3), rubber block glued to clamping disc (4), threaded clamping disc (5), fastening (6), loose (7), in clamped position (8)

5.7 Thermoforming tubes and rods

Free bending of tubes of

PLEXIGLAS® GS and PLEXIGLAS® XT is performed without support, i.e., when an angle bend is made in a tube its walls are not supported either internally or externally; and they are not filled or held by bending jigs.

For heating in the oven, the fabricator can choose between three possible fixing methods for the tube when it becomes rubbery-elastic:

- **placing the tube upright** on a flat support or centering plug, provided the tube length does not noticeably exceed its diameter and the wall thickness is adequate (see Fig. 38);
- **suspending the tube by means of centering discs at both ends**, provided the tube is thick-walled and its length does not exceed three times its diameter (see Fig. 39);
- **suspending the tube with a bell-shaped holding collar at the upper end**, if the tube is very long and thin-walled (see Fig. 40).

The smallest possible bending radius when heated depends on the tube diameter (d) and also partly on the wall thickness. The table lists the standard minimum permissible bending radii typical for free bending of PLEXIGLAS® tubes with outside diameters of 10 to 60 mm. As long as these radii are observed, a negligible change of the circular cross-section to oval will occur. Given larger radii, this change is caused by tensile stress generated along the outer curvature, which counteracts the compressive stress along the inside curvature. When a certain stress limit is exceeded, the tube may actually buckle.

For tubes made of PLEXIGLAS® XT, these empirical values signify that heating has to take place in a very narrow temperature range, which must be determined under the respective heating conditions.

For work requiring very accurate angles, a bending jig should be used. Allowance must be made for the fact that the tube angle will expand slightly on cooling (see 5.1).

For tube angles with a smaller radius, thermoforming of two half-shells

from sheet material and bonding them together is recommended. This is especially true for larger dimensions.

tube diameter (mm)	Min. permissible bending radius (mm)
10	80
20	100
30	120
40	150
50	190
60	250

For high-definition thermoforming with an exterior wall support, a bending jig must be used that supports the internal and external curvature of the tube and counteracts the tendency to oval deformation of its cross-section (see Fig. 41)

In order to prevent the tube from buckling, as noted above, an interior support may be used for bending. The use of sand, gypsum, prepared chalk, and other materials in powder form, as commonly employed for bending metal pipes, is not possible with transparent plastic tubes because they would become dull on the inside surface. Suitable interior-support materials that do not noticeably affect the brilliancy of the tubing are

- rubber rings,
- metal spirals in a rubber sleeve,
- nested rubber tubes.

These elastic interior supports can normally be pulled out of the cooled bend with ease after hot curving and cooling of the PLEXIGLAS® tube if they are sprinkled with talcum before insertion.

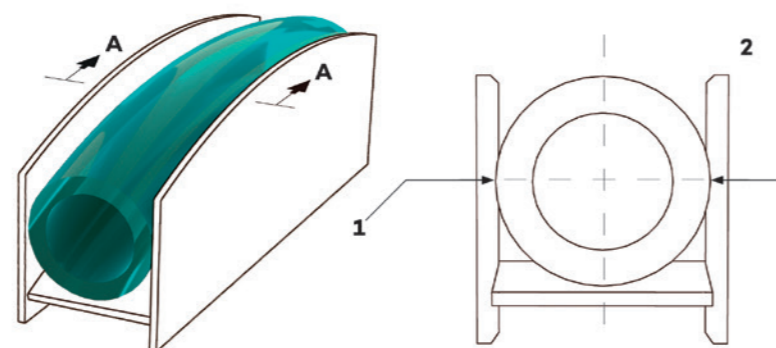

Fig. 41: Thermoforming a tube of PLEXIGLAS® GS or PLEXIGLAS® XT in a bending jig. Lateral support (1), section A-A (2).

An essential prerequisite in this case is that the supports match the inside diameter of the tube very accurately. If this is so, the minimum permissible bending radius for free bending (see table above) can normally be further reduced by one third. Pronounced marking on the inside of the tube bend may, however, be unavoidable in this case.

Finally it may be possible to use a tube with a smaller diameter than is actually required, but with a somewhat thicker wall, and to form it with air pressure in a two-piece hollow mold (see Fig. 42) of the desired bend dimensions (see also Expansion with air pressure below).

An uncommon but nevertheless feasible forming method is scarfing, whereby the end of one tube is expanded at forming temperature with the aid of a mandrel and then pushed over and shrunk onto the end of another tube. This „splicing“ method is suitable mainly for PLEXIGLAS® GS and to a lesser degree for PLEXIGLAS® XT. The mandrel can be made of hardwood, metal, or plastic. Its removal after coating may be difficult, but it becomes easier if the mandrel is heated as well prior to forming.

The considerable amount of friction between the interior wall of the tube and the mandrel limits the possible enlargement of the diameter, which is about three times the wall thickness, however. The expansion depth (scarf length) reaches its maximum at 1.5 times the tube diameter.

A very accurate fit is achieved by subsequently pushing the expanded tube over another tube with the original cross-section and heating it locally by means of hot air so that it shrinks on. The same applies to drawing onto other materials. However, the core circumference must not be smaller than the original internal circumference of the tube. Since the shrunk-on tubes are internally stressed, the influence of aggressive media may result in crazing. Stress-relieving annealing is therefore essential (see the Guidelines for Workshop Practice „Machining PLEXIGLAS®“ brochure under ‚8 Annealing‘).

For some applications, tubular shapes with a cornered cross-section are required. They can be formed using an expander. For this purpose, tubes of PLEXIGLAS® GS, which are mechanically expanded to a cornered shape with parallel sides or conical form once they have been heated to forming temperature, will normally be selected. Expanding tubes with compressed air corresponds to stretch-forming of sheets with female molds and is mainly used for the manufacture of conical tubes and tubes with changing or non-circular cross-sections. Here too, the wall thickness decreases as the degree of stretching increases. If the cross-section remains the same over the entire length of the tube, the latter can be expanded up to two or three times the original diameter (see Fig. 43).

The molds must be able to withstand the forming pressures that arise. The molds must be able to withstand the forming pressures that arise. For complex parts, the molds should be heated. Depending on the tube diameters, special clamping or sealing devices (see 5.1) must be used. When the heated tubes are placed in the molds, they should be under slight tensile stress in the axial direction, so as to prevent the tube walls from caving in or the tubes from sagging. Molds for long tubes should be designed in such a way that the heated tubes can be vertically suspended in them. Otherwise, defective moldings may be obtained, or—especially with PLEXIGLAS® XT—the tube walls will stick together.

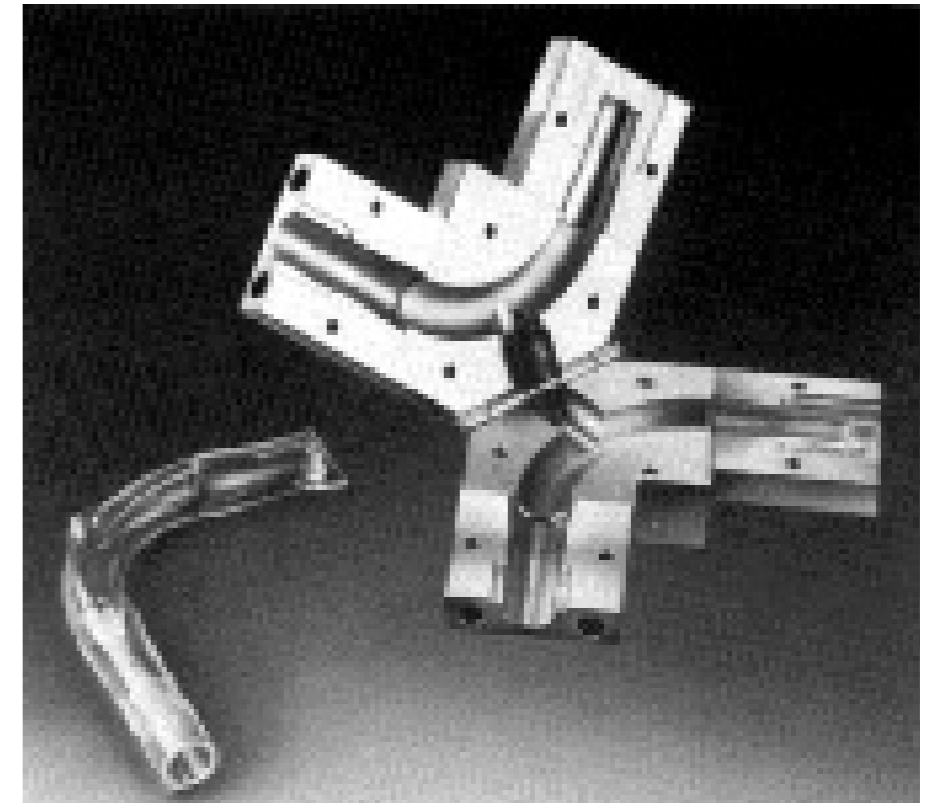

Fig. 42: Air-pressure mold for tube bending

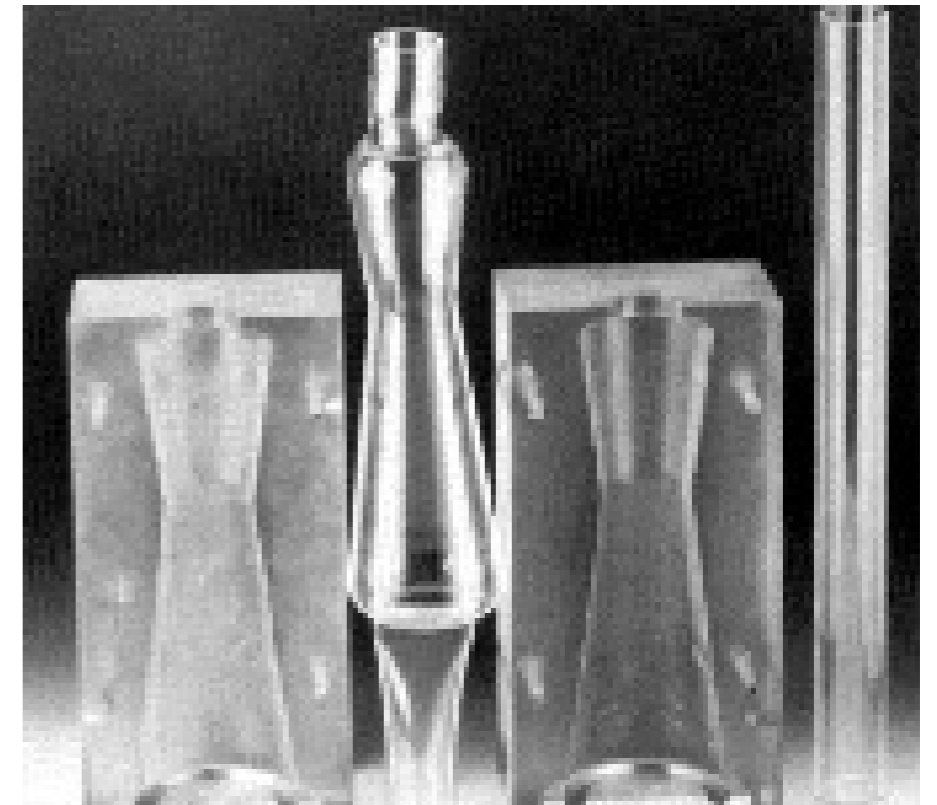

Fig. 43: Mold for expanding tubes by means of compressed air

Round and square rods of PLEXIGLAS® GS and PLEXIGLAS® XT are thermoformed similarly to tubes with the aid of exterior supports. Forming in this case usually means **curving or straight-line bending**. For molded rods with rectangular or square cross-sections, our recommendations are the same as for sheets. Circular cross-sections

behave like tubes supported on the inside. Generally speaking, the bending radii should be as large as possible in order to avoid pronounced changes in the bend. If square PLEXIGLAS® rods have to be **turned/twisted** on the longitudinal axis while warm, this can often be advantageously performed between the chuck and tailstock on a lathe.

Every now and then, **stretched round rods** of PLEXIGLAS® GS are required, such as for the manufacture of **shrink rivets**. To this end, a round rod is first heated to the forming temperature and then clamped into a lathe, for example, where the rod, with chuck and support, is uniaxially stretched by up to 70%.

6. Cooling

When cooling down, moldings of PLEXIGLAS® GS and PLEXIGLAS® XT should remain firmly clamped under the influence of the forming forces. Removal from the mold should only occur when adequate dimensional stability is guaranteed. This is the case when the temperatures of PLEXIGLAS® GS and PLEXIGLAS® XT have dropped below

PLEXIGLAS® GS: 70 °C
PLEXIGLAS® XT: 60 °C

What is important is that the entire cross-section of the molding has reached this temperature.

Cooling should occur gradually in order to reduce the resultant stress to a minimum. Since acrylic glass has low thermal conductivity, thick pieces cool very slowly and should therefore be covered with a soft cloth or suitable heat-insulating material after removal from the mold, in order not to expose them to air drafts and to achieve an effect similar to annealing.

The molding, which previously expanded on exposure to heat, contracts upon cooling. This change in dimension must not be impeded, so as not to generate stress within the material. If stress is likely to build up when the molding shrinks back to the mold, removal from the mold should occur as soon as the part has assumed a

stable shape, i.e., possibly even before the above temperatures have been reached. Moldings of PLEXIGLAS® are more likely to tear if cooling on the mold takes too long and subsequent shrinkage of the molding produces high stress.

Depending on type and design, the accuracy and planarity of the removed workpiece can be favorably influenced by the cooling method, such as by

- placing it on a level support with a small surface where it is evenly accessible to the ambient air for uniform and warp-free cooling; this is the most widely used method for simple moldings (see Fig. 44).
- placing it in the open on a level support made of insulating material and locally clamping it or loading it with weights so as to prevent design-related warpage after cooling; examples are lighting covers, bath-tubs, domed skylights, and signs (see Fig. 45).
- placing the molding on a heat-insulating support and covering it with layers of insulating cloth so as to ensure slow and uniform cooling. If the moldings can be stacked for cooling, insulating material must be inserted between them. This method is generally recommended for thick-walled items (see Fig. 46)

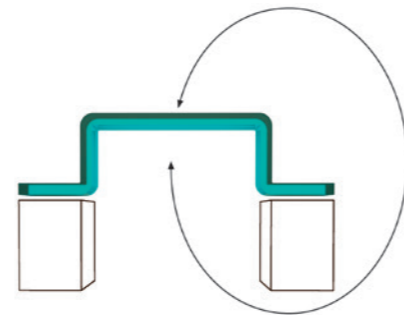

Fig. 44: Moldings resting freely on a level support

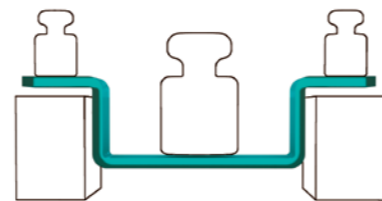

Fig. 45: Moldings loaded with weights

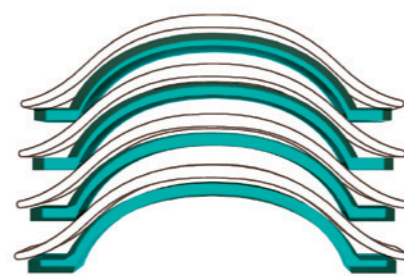

Fig. 46: Stacked moldings with heat-insulating material in-between

7. Tools

7.1 Molds

PLEXIGLAS® and PLEXIGLAS® XT can be formed using simple molds. Suitable mold materials are wood, laminates, metal or casting resins. The choice of material depends on the requirements:

- mechanical stress,
- desired lifetime,
- dimensional stability,
- thermal conductivity,
- machinability,
- weight,
- material and manufacturing costs.

Blowing into female molds creates a high amount of mechanical stress. For this purpose, the molds should be made of steel or aluminum and designed and tested for the expected load. Less highly stressed molds can be made of casting resins, and simple molds for drape forming without undue mechanical stress, of wood or plastic.

The lifetime of a mold depends on the number of moldings to be produced and the mechanical and thermal stress involved.

The forming method—into female molds or over male molds—determines the required dimensional tolerance of the mold. Due to the high coefficient of thermal expansion of acrylic glass, PLEXIGLAS® GS and PLEXIGLAS® XT **shrink** noticeably on cooling. Therefore the molds must have a corresponding oversize, depending on the mold material, of between **0.5 and 0.8%** more than the nominal size of the molding.

For easy removal of the molded items, male molds, depending on their height, should have a **draft angle of 1° to 3°**. With female molds this is usually unnecessary, because the molding shrinks back from the mold surface on cooling.

When stating the different forming temperatures (see 2.1), we pointed out that different **mold temperatures** may be required for different techniques. Metal molds (heat con-

duction!) may be provided with heating and cooling ducts for accurate temperature control.

The surface of the finished item is influenced by the selected molding temperature and the **mold's surface**. Given direct contact between the blank and the mold, the surface of the latter must be fine-ground or have a matte-polished (not high-gloss polished) finish. If the mold material does not permit this treatment, apply a coat of paint or casting resin that can be sanded and finely matted.

Should air pockets form between the mold and molding during the process, vent holes must be provided. They must be very small (0.5 to 1.0 mm in diameter) in order not to leave traces on the formed item. In order to extract the air as quickly as possible, the vent holes are enlarged from the back of the mold (see Fig. 47).

Wooden molds are ideal for small runs and where little stress is generated during forming. Small molds are made of solid wood, larger ones with curved surfaces—such as cylindrical or conical molds—of hardboard or

plywood. For large runs or more highly stressed molds, we recommend the use of laminates. Since a porous wood surface would mark the molding, it has to be treated with a filler paste and then fine-ground or better yet covered with a soft elastic cloth.

Wooden molds are inexpensive and easy to repair and modify. For individual forming operations or small runs, their poor heat conductivity is an advantage. Disadvantages are the low load-bearing capacity and the tendency to split and warp.

Molds made of PLEXIGLAS® GS can only tolerate the forming temperatures required for plastic blanks and the mechanical stress of forming for a short time. Their use makes sense only where transparent molds are required to demonstrate complex forming processes, such as for studies or small trial runs. Since PLEXIGLAS® GS is a poor conductor of heat, the material to be formed cools down slowly, but its mirror-smooth surface may entrap air bubbles during forming, and this can lead to optical distortion.

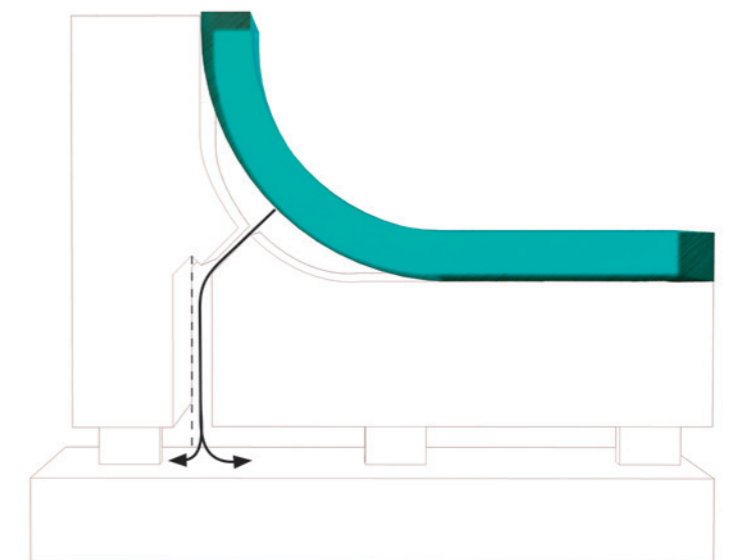

Fig. 47: Vent hole in the mold

Molds made of metal—usually aluminum alloys—are either cast or fabricated from sheet stock. They are used for large runs. A high-gloss mold surface may cause mark-off (spots), so a satin finish is preferred.

The advantages of metal molds are:

- high accuracy and surface quality,
- control of surface temperatures by means of heating elements,
- fast cooling due to incorporated cooling system,
- generally long life.

Apart from solid molds, so-called skeleton molds are used for simple, usually transparent items of high optical quality. The skeleton normally consists of metal tubes, rods, or bars. They form the outer contour of the molding, the areas between the rods remaining open. The material heated to the forming temperature thus rests against the skeleton but not against the open areas.

Fig. 48 shows examples of **skeleton molds**. Depending on the size of the opening in the contour plate, molds with right angles or with sides at different angles can be manufactured (see Example 2 in Fig. 48). Aesthetic appearance, planarity, and retention of the original sheet thickness across the main flat surface of the molding are achieved by heating with IR radiators, provided this area—indicated in Example 3 by a dotted line—is covered with an aluminum sheet during heating. Only the surrounding area is thermoformed by vacuum in this case.

Molds made of polymeric casting compounds are usually manufactured from epoxy resins (EP). An advantage here is that the mold need not be machined at all or only to a minor extent after casting. When using polymeric casting compounds, the following measures are recommended:

- adding fillers for cost reduction,
- inserting reinforcements such as glass-fiber laminates to improve strength,
- mixing with metal powder, such as aluminum powder, to increase the thermal conductivity of the mold, thereby shortening the cycle times, for example.

There are several different manufacturing techniques for meeting the varying requirements for the mold. The producers of casting resins have the relevant information. Constructing a cast resin mold can be a do-it-yourself job if the supplier's instructions are observed.

Unlike epoxy resins, unsaturated polyester resins (UP) as mold materials have the disadvantage that their extended-service temperature is exceeded by the forming temperature of the plastics being formed. This not only causes strong odors but also leads to softening and dimensional changes.

For models or prototypes, it is also possible to use **gypsum molds**. Because of their low mechanical strength, suitable reinforcements need to be cast in.

In order to facilitate the forming process, it is common practice to apply mold grease, silicone oil, talcum, or a PTFE coating to exposed areas. These ancillary forming agents usually require perfectly clean molding surfaces to permit good adhesion for subsequent operations like painting, bonding, GF-UP reinforcement, etc.

Example 1: Audioequipment cover

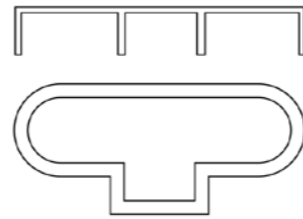

Example 2: Box

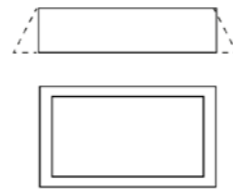

Example 3: Tray



Fig 48: Various skeleton molds

7.2 Clamps

For thermoforming, sheets of PLEXIGLAS® GS and PLEXIGLAS® XT must be fixed to the mold with either rigid or spring-loaded clamps, depending on the forming technique. If pneumatic or vacuum-forming techniques are used, it is also important to seal the air-pressure or suction chamber against the blank to be formed, by means of the clamping frame or the clamping areas.

For forming techniques in which the clamped material is exposed only to low tensile forces, the clamping areas may be smooth or slightly roughened. Increased tensile forces, however, would require excessive clamping forces. Therefore, the clamping areas should be designed in such a way that they hold the material securely during forming, with a minimum of clamping elements or clamping forces. At the same time, the clamped areas must ensure effective sealing where necessary. Fig. 49 shows examples of a wide variety of possible clamping area designs.

The necessary clamping forces are applied either by hydraulic presses or by mechanical, pneumatic, or hydraulic clamping elements (Fig. 50).

For slip-pressure forming (see 5.3) and some combined forming processes, spring-loaded clamping elements are required. They should permit adjusting the clamping forces according to need. This can be done in steps by using springs of varying strength, continuously by pretensioning the springs, or by electronic control.

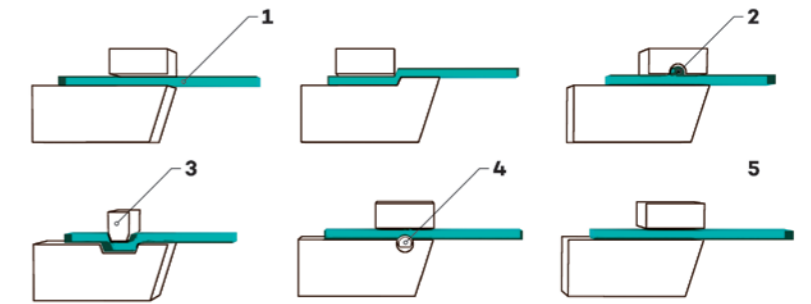

Fig. 49: Design of clamping areas. PLEXIGLAS® blank (1), soldered-in steel wire (2), clamping frame (3), rubber ring (4); sealing strip, predominantly for slip-pressure forming where the material is to slide inwards (5).



Fig. 50: Clamping elements for mechanical and pneumatic or hydraulic operation

POLYVANTIS GmbH

Riedbahnstraße 70
64331 Weiterstadt
Germany

www.plexiglas.de
www.polyvantis.com

® = registered trademark

Semi-finished polymethyl methacrylate (PMMA) products from POLYVANTIS are sold on the European, Asian, African and Australian continents under the registered trademark PLEXIGLAS®, in the Americas under the registered trademark ACRYLITE®, both owned by Röhm GmbH, Darmstadt, or its affiliates.

Certified to DIN EN ISO 9001 (Quality) and DIN EN ISO 14001 (Environment)

This information and all further technical advice is based on our present knowledge and experience. However, it implies no liability or other legal responsibility on our part, including with regard to existing third party intellectual property rights, especially patent rights. In particular, no warranty, whether express or implied, or guarantee of product properties in the legal sense is intended or implied. We reserve the right to make any changes according to technological progress or further developments. The customer is not released from the obligation to conduct careful inspection and testing of incoming goods. Performance of the product described herein should be verified by testing, which should be carried out only by qualified experts in the sole responsibility of a customer. Reference to trade names used by other companies is neither a recommendation, nor does it imply that similar products could not be used.

Ref. no. 311-2 07/24 (en)